

UNIVERSITAT DE VALÈNCIA

BIBLIOTECA DE BELLES ARTS

REVUE

RESPECT

ATLAS

11

Reg. 1700  
Cota B-2  
362

Nº sistema

103808

# LEÇONS NOUVELLES

DE

# PERSPECTIVE,

PAR A. CHEVILLARD,

PROFESSEUR A L'ÉCOLE IMPÉRIALE DES BEAUX-ARTS.



---

ATLAS. — 32 PLANCHES.

---

PARIS,

GAUTHIER-VILLARS, IMPRIMEUR-LIBRAIRE

DU BUREAU DES LONGITUDES, DE L'ÉCOLE IMPÉRIALE POLYTECHNIQUE,

SUCCESSEUR DE MALLET-BACHELIER,

Quai des Augustins, 55.

1868

RECUEIL NOUVELLES

DE POÉSIES

PARIS. — IMPRIMERIE DE GAUTHIER-VILLARS, SUCCESSION DE MALLET-BACHELIER,  
Rue de Seine-Saint-Germain, 10, près l'Institut.

GAUTHIER-VILLARS, IMPRIMEUR

1868

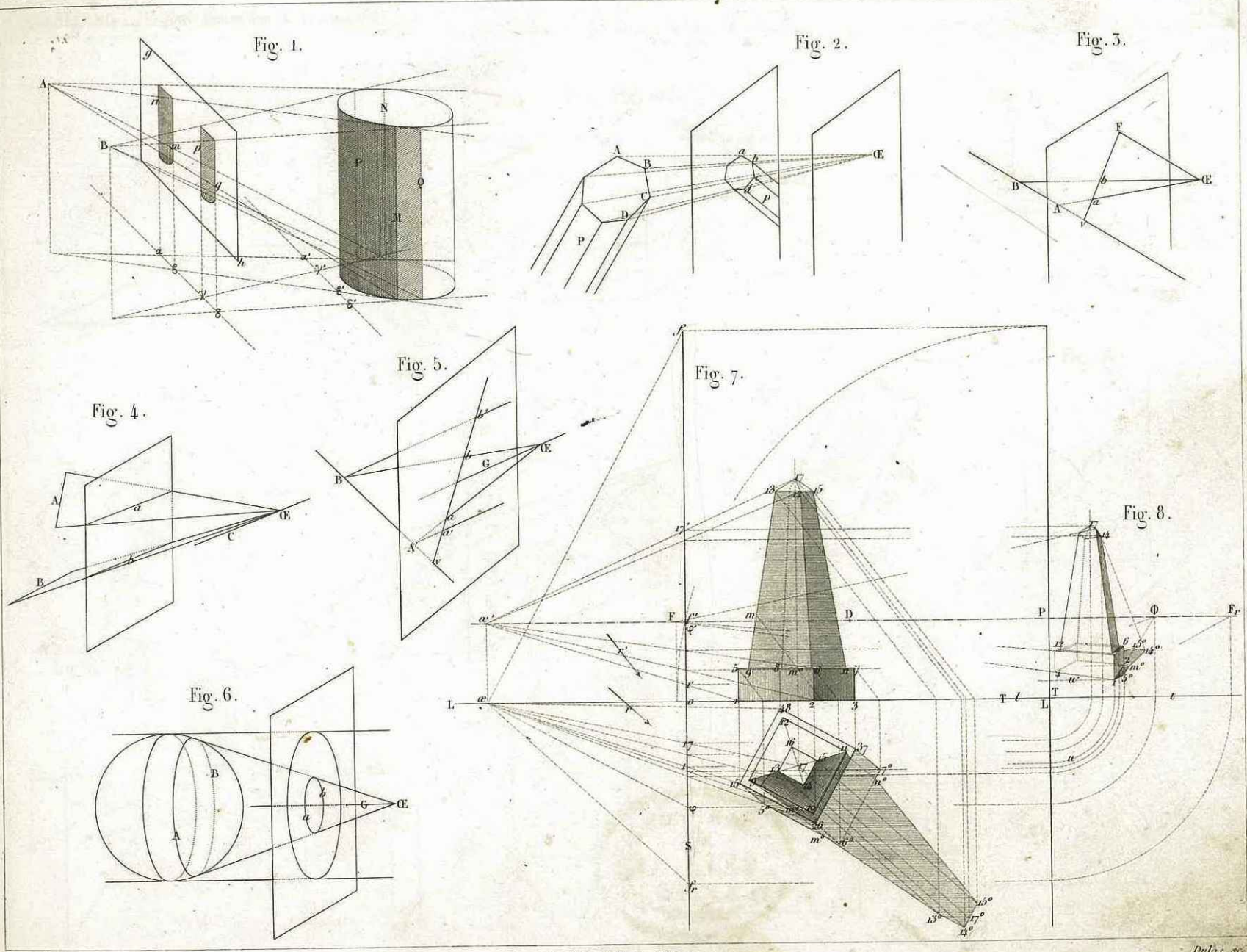
## TABLE DES PLANCHES.

---

- CHAPITRE I. — Définitions et principes. (Figures 1 à 12; Planches I à II.)
- CHAPITRE II. — Perspective des horizontales données en plan et élévation. (Figures 13 à 48; Planches II à VI.)
- CHAPITRE III. — Perspective des ombres. (Figures 49 à 68; Planches VI à VIII.)
- CHAPITRE IV. — Échelles de perspective. (Figures 69 à 86; Planches VIII à X.)
- CHAPITRE V. — Perspective immédiate. (Figures 87 à 124; Planches X à XIV.)
- CHAPITRE VI. — Perspective inverse. (Figures 125 à 130; Planches XIV à XV.)
- CHAPITRE VII. — Cercle horizontal. (Figures 131 à 146; Planches XV à XVII.)
- CHAPITRE VIII. — Extension des méthodes précédentes au cas général d'un plan quelconque donné par sa trace et sa ligne d'évanouissement. (Figures 147 à 173; Planches XVII à XXI.)
- CHAPITRE IX. — Cylindre, cône, sphère. (Figures 174 à 199; Planches XXI à XXV.)
- CHAPITRE X. — Surface de révolution. (Figures 200 à 213; Planches XXV à XXVIII.)
- CHAPITRE XI. — Perspective générale. (Figures 214 à 239; Planches XXIX à XXXII.)

*Nota.* — Les Planches peuvent être reliées en un volume in-8°, format du texte.

---



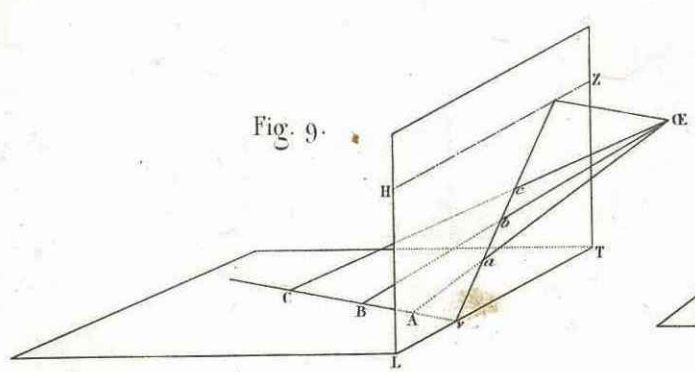


Fig. 9.

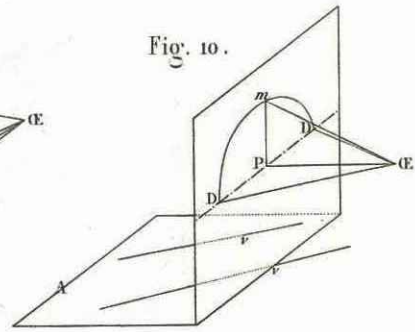


Fig. 10.

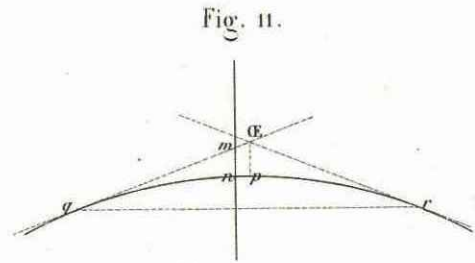


Fig. 11.

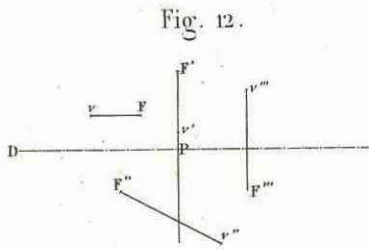


Fig. 12.

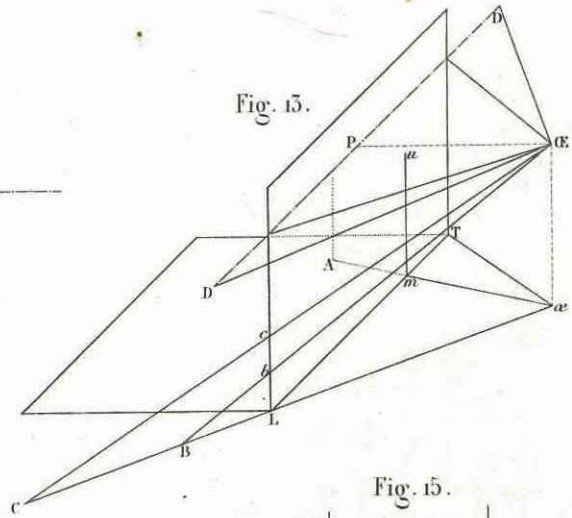


Fig. 13.

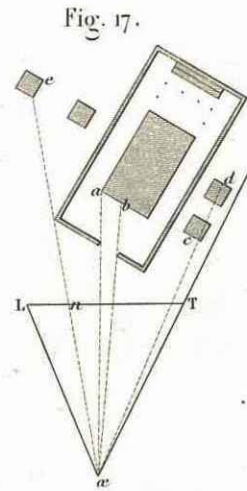


Fig. 17.

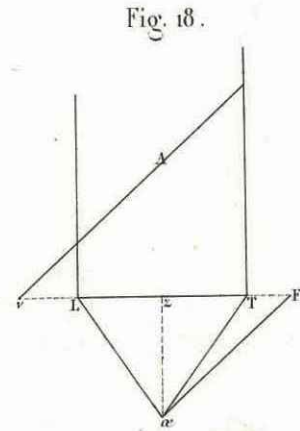


Fig. 18.

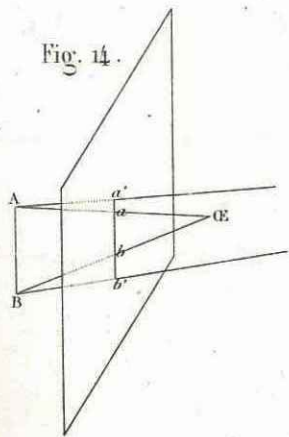


Fig. 14.

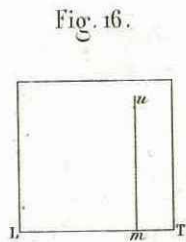


Fig. 16.

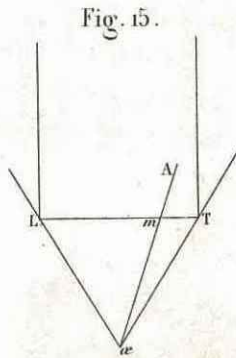


Fig. 15.

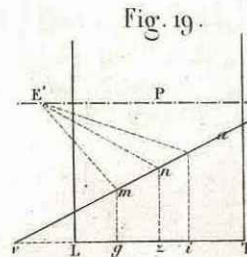


Fig. 19.

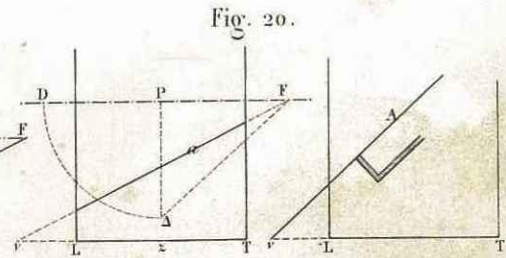


Fig. 20.

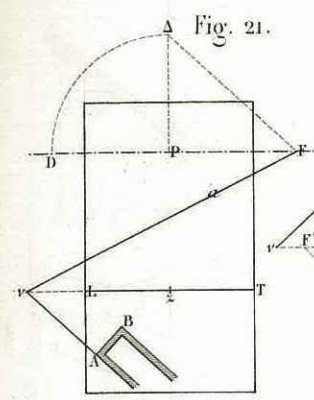


Fig. 21.

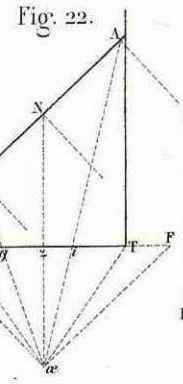


Fig. 22.

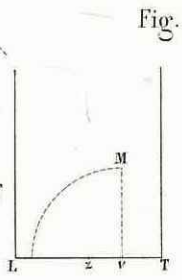


Fig. 23.

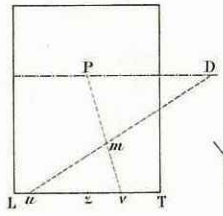


Fig. 24.

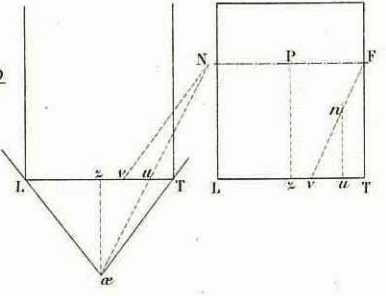


Fig. 25.

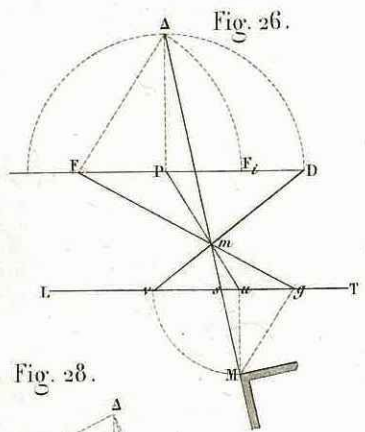
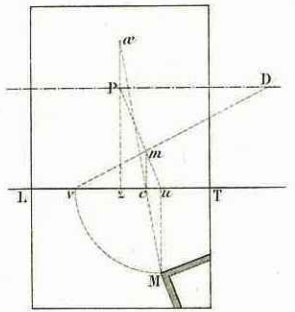


Fig. 26.

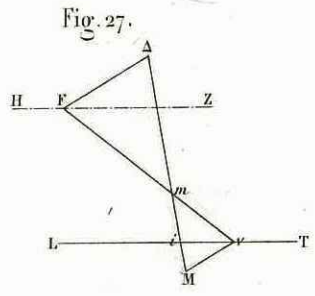


Fig. 27.

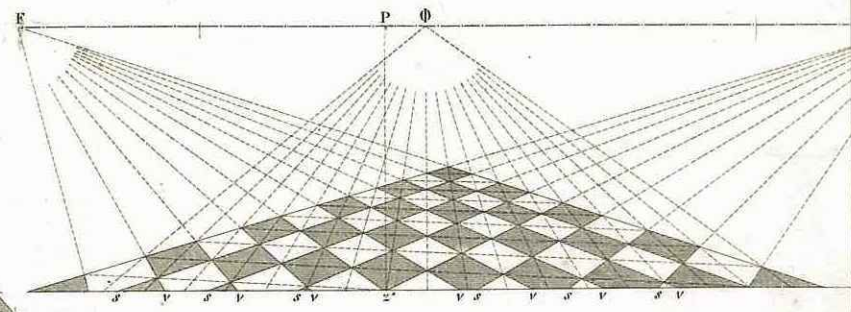


Fig. 29.

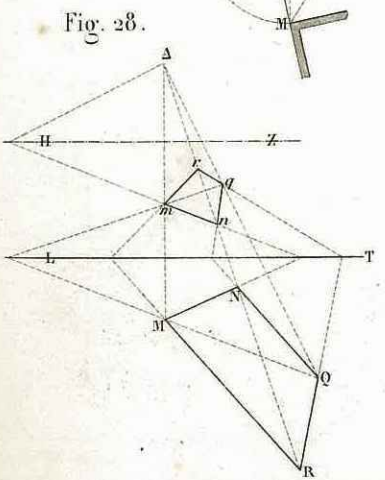


Fig. 28.

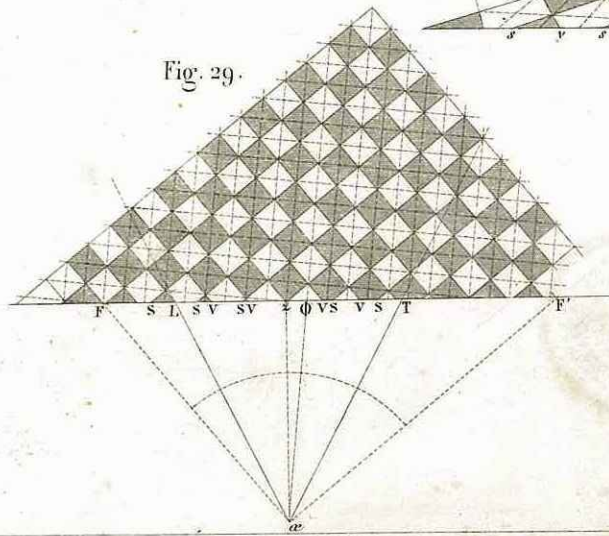


Fig. 30.

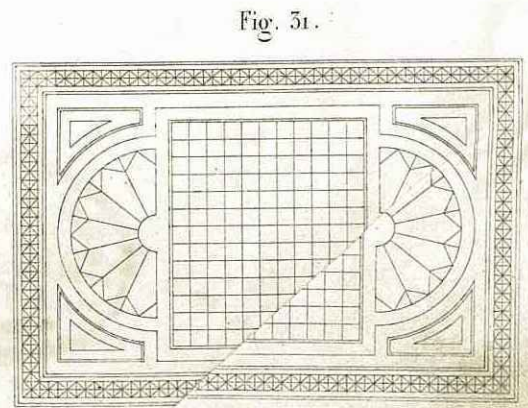


Fig. 31.



Fig. 32.

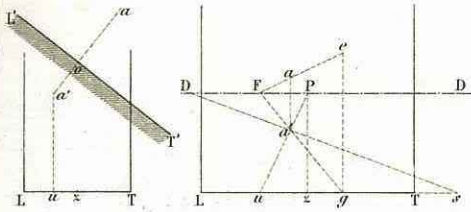


Fig. 35.

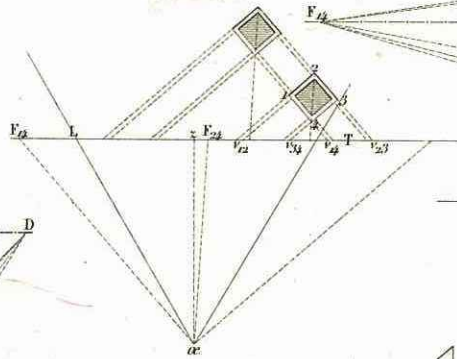


Fig. 34.

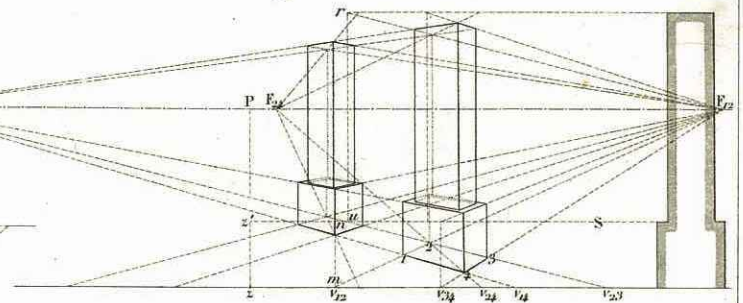


Fig. 37.

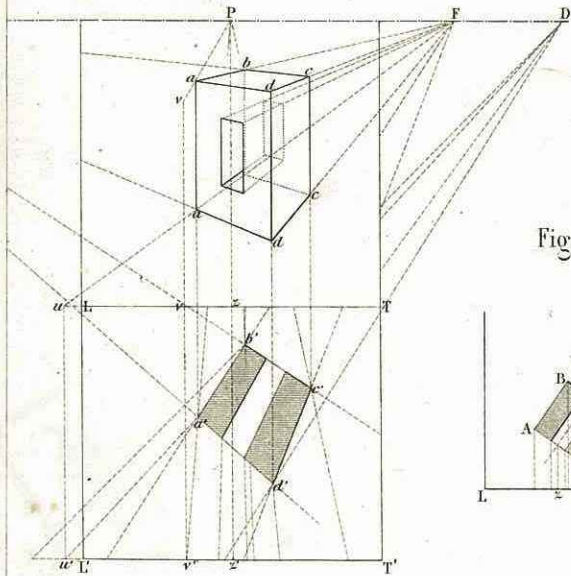


Fig. 36.

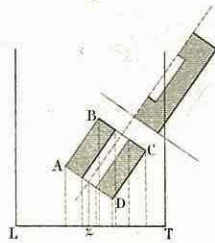


Fig. 35.

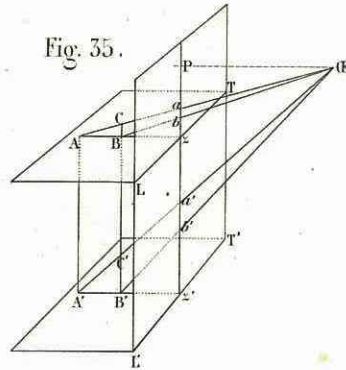


Fig. 38.

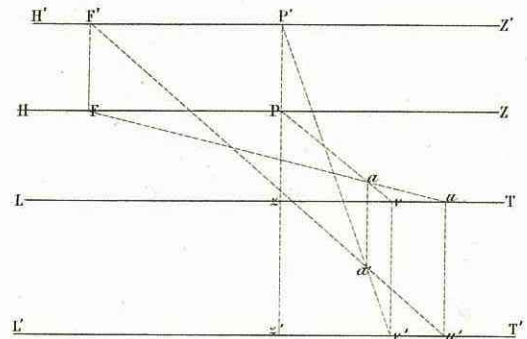


Fig. 40.

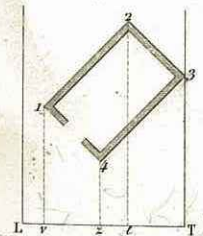


Fig. 41.

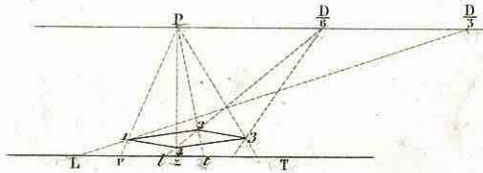


Fig. 42.

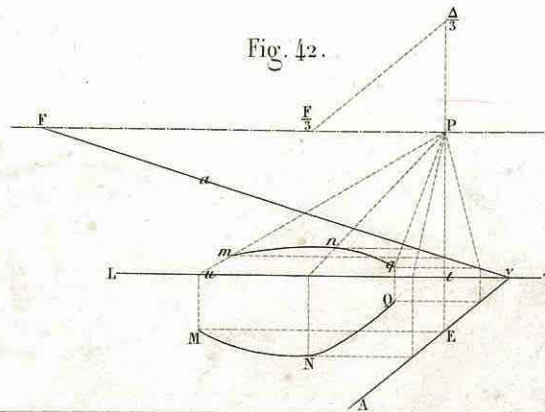


Fig. 43.

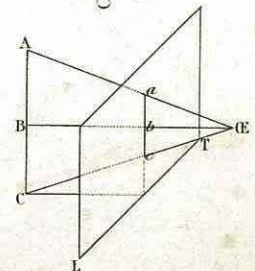


Fig. 44.

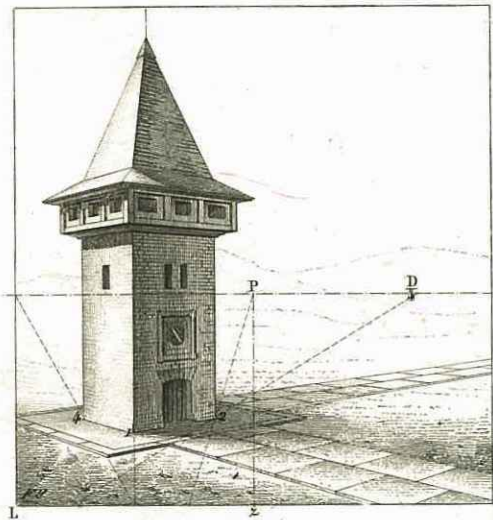


Fig. 39.

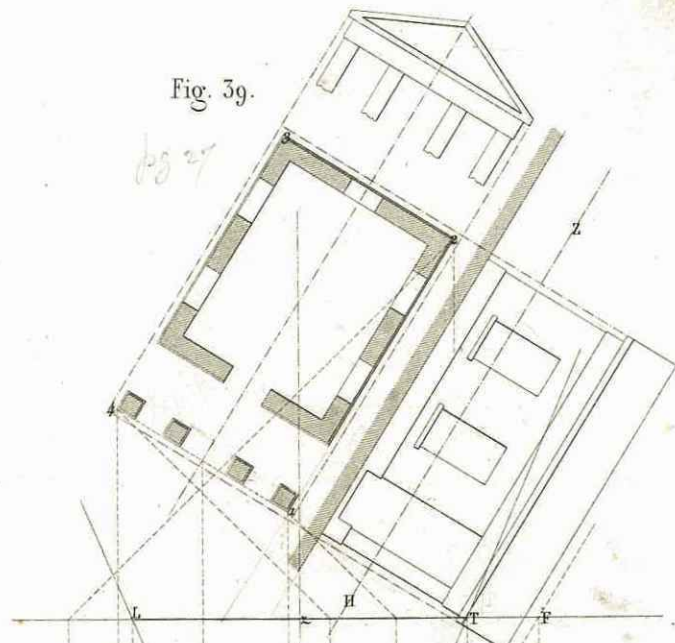


Fig. 45.

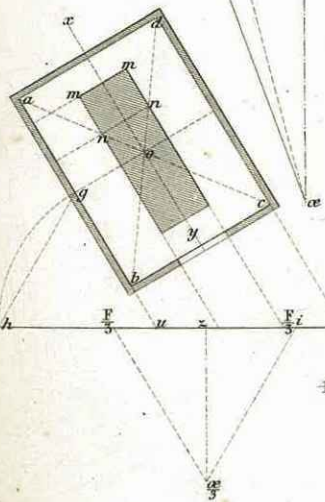


Fig. 46.

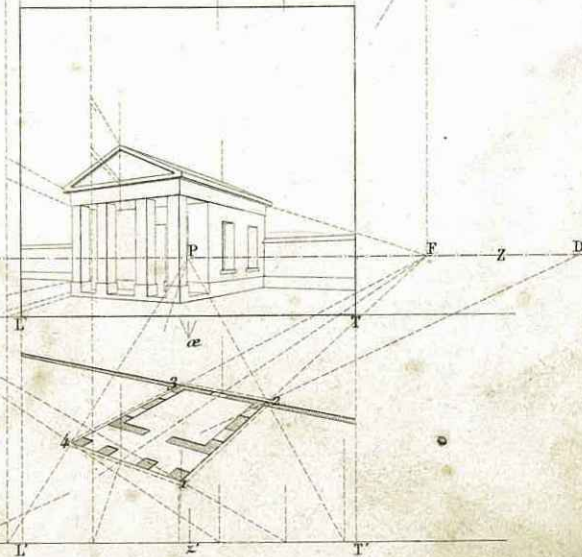
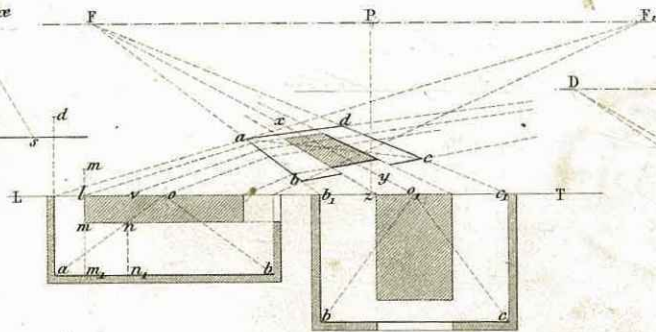


Fig. 47.

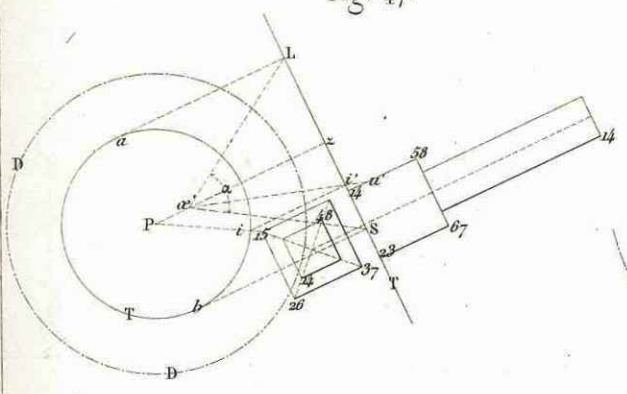


Fig. 48.

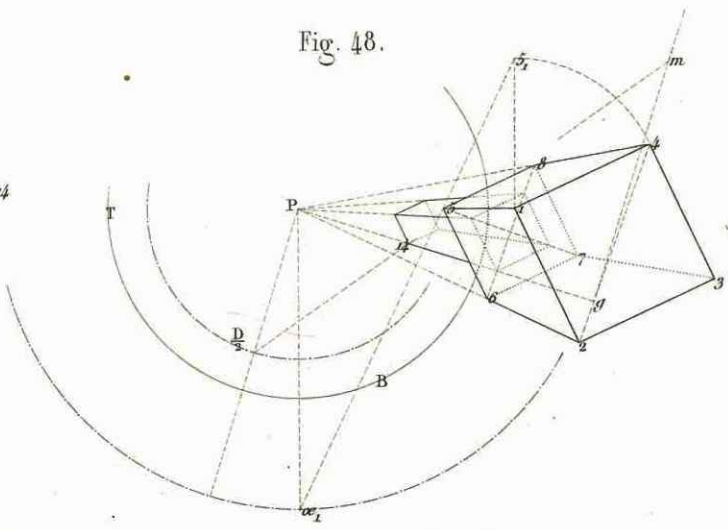


Fig. 49.

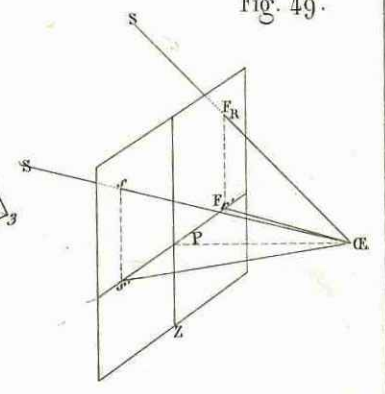


Fig. 50.

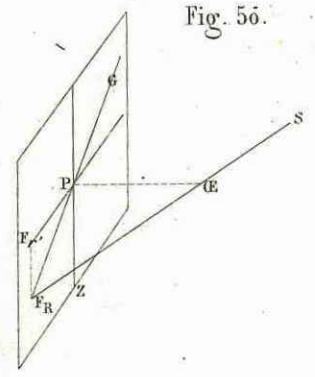


Fig. 51.

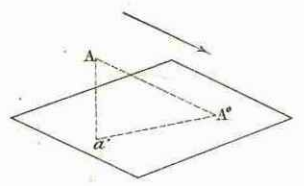


Fig. 52.

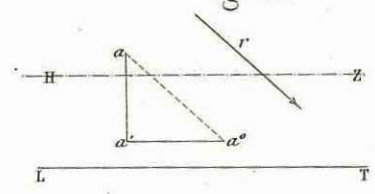


Fig. 53.

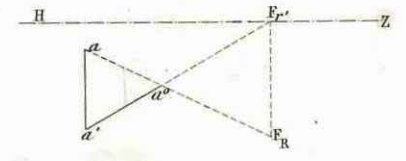


Fig. 54.

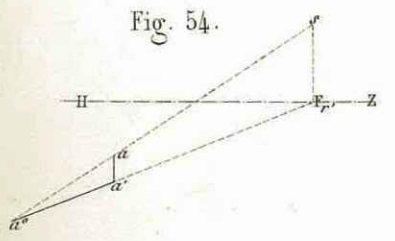


Fig. 55.

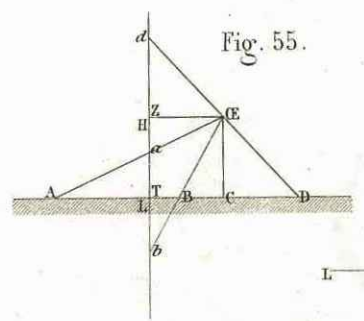


Fig. 56.

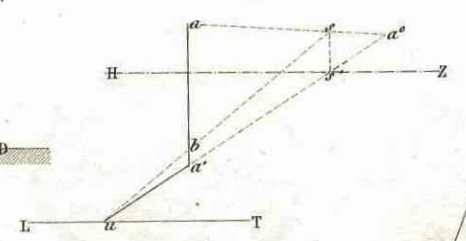


Fig. 57.

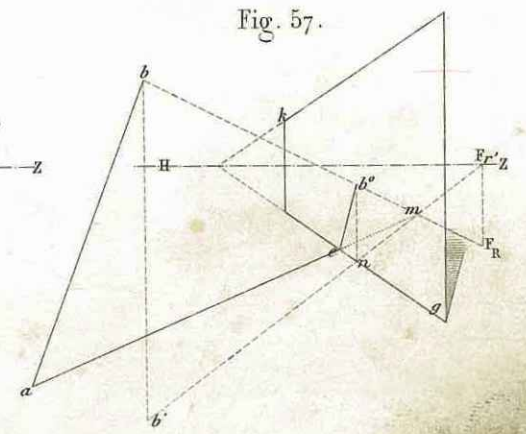


Fig. 58.

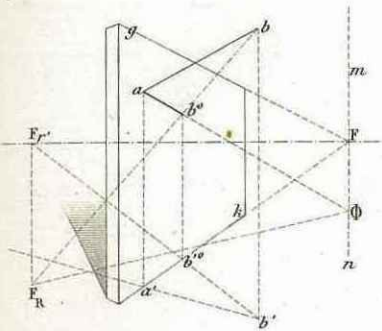


Fig. 59.

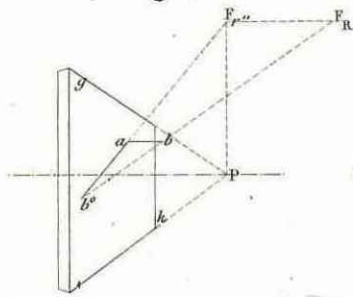


Fig. 60.

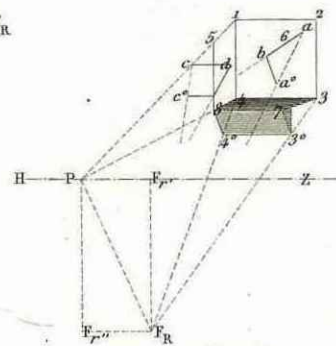


Fig. 61.

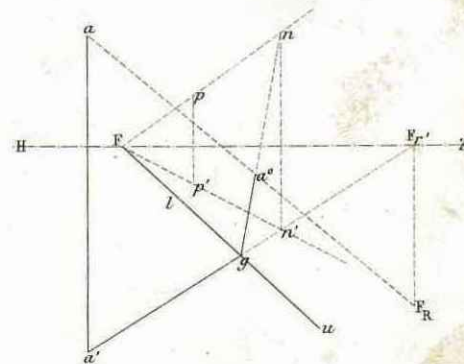


Fig. 63.

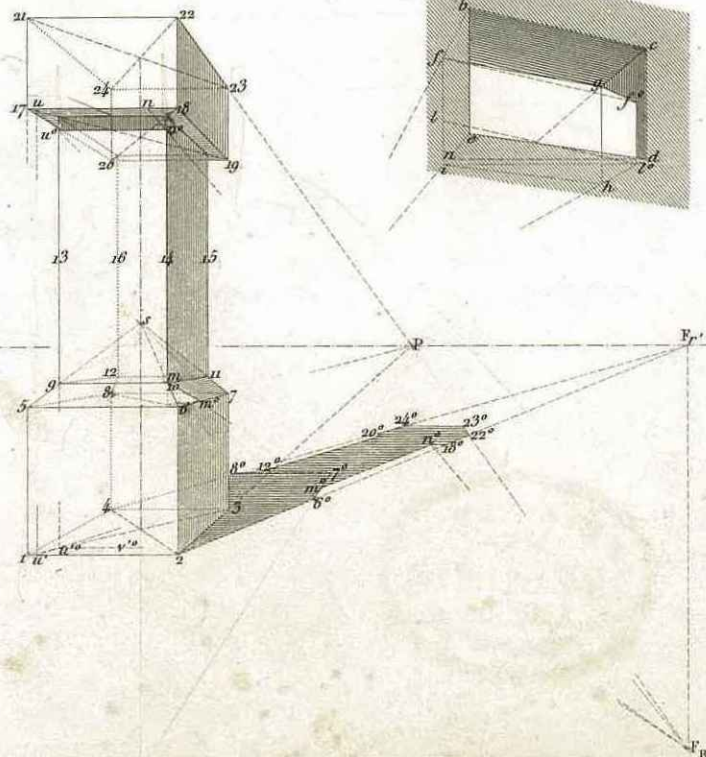


Fig. 65.

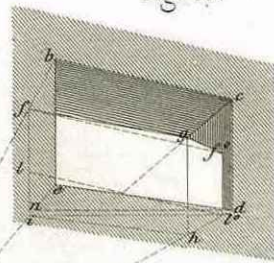


Fig. 62.

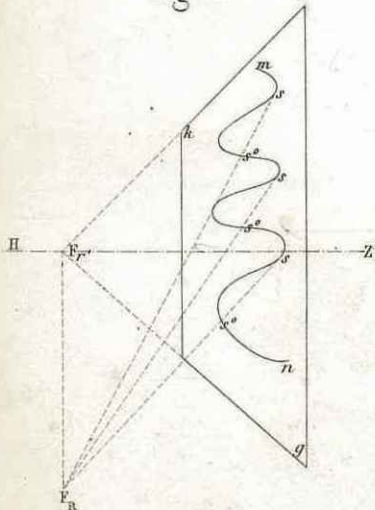


Fig. 64.

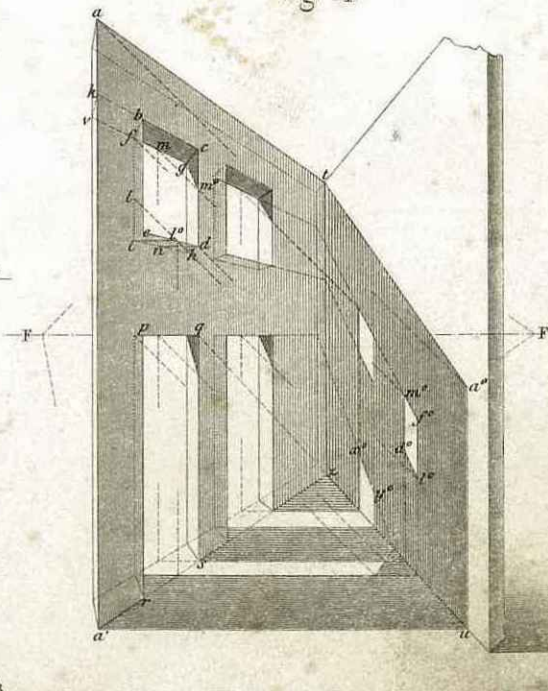


Fig. 66.

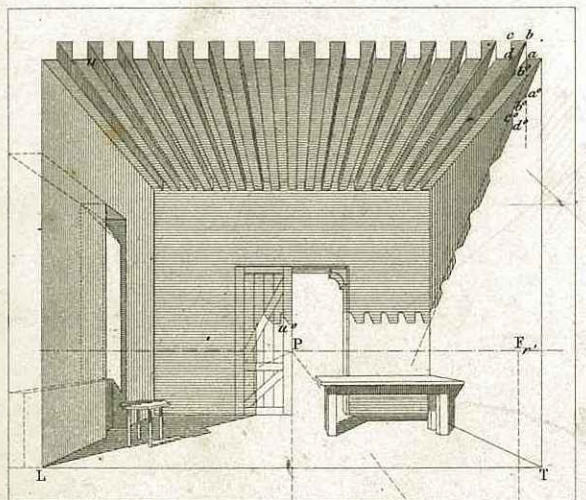
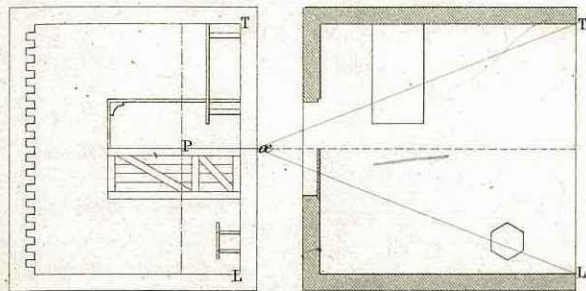
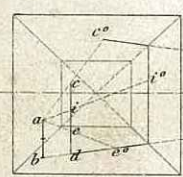


Fig. 67.



$E_{r''}$   $F_R$

$\psi$   $\psi$

Fig. 69.

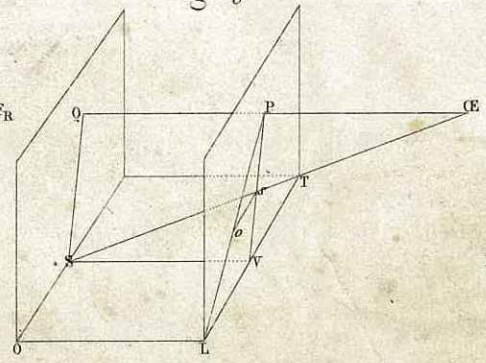


Fig. 68.

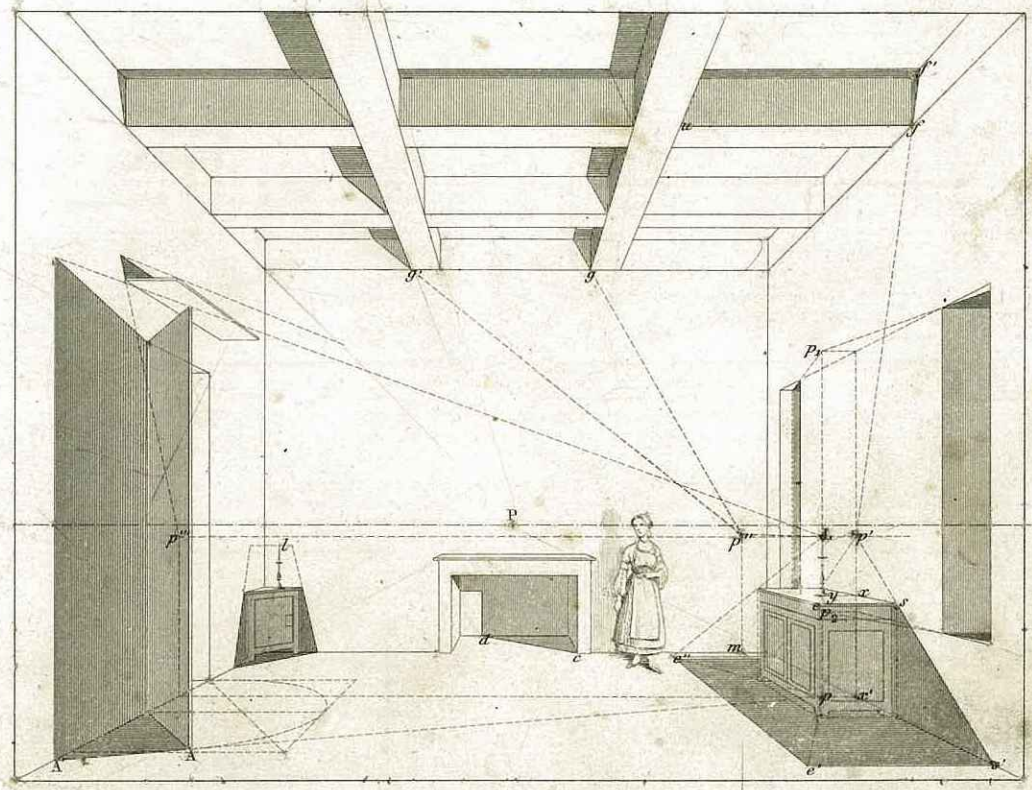


Fig. 70.

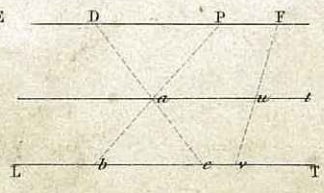


Fig. 71.

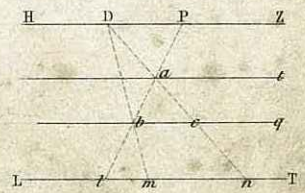


Fig. 72.

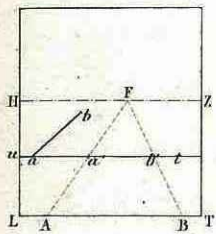


Fig. 75.

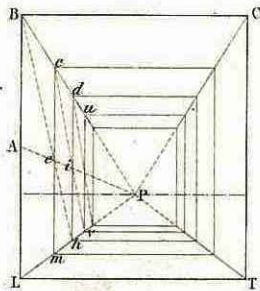


Fig. 78.

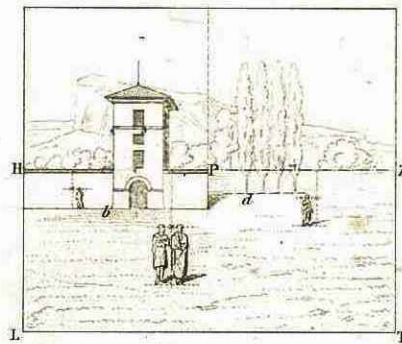


Fig. 79.

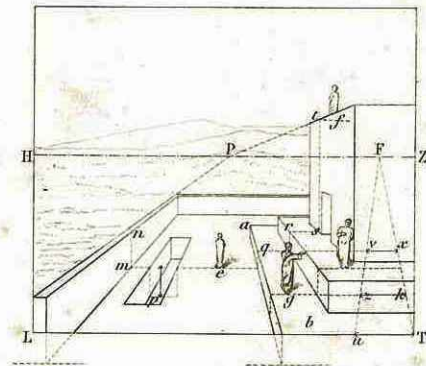


Fig. 75.

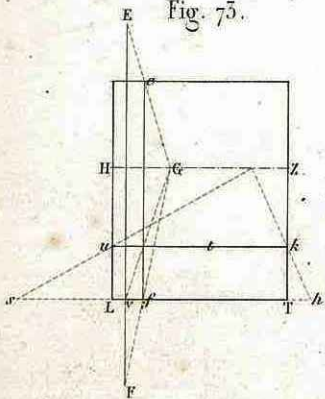


Fig. 76.

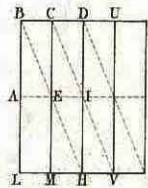


Fig. 77.

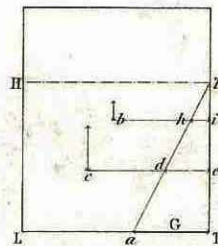


Fig. 82.

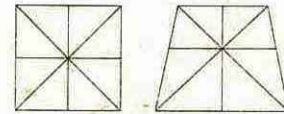


Fig. 74.

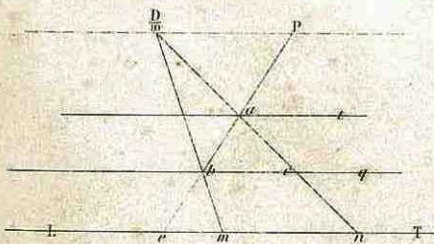


Fig. 80.

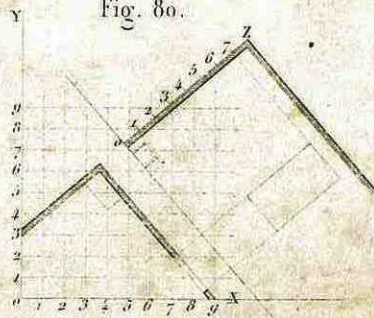


Fig. 81.

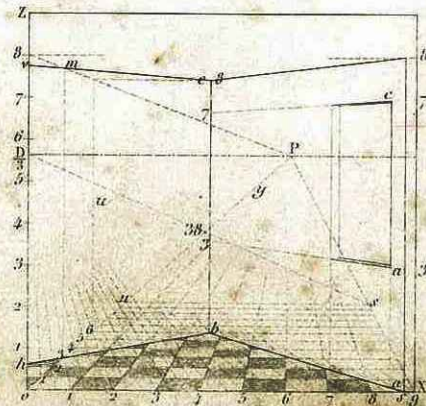


Fig. 85.

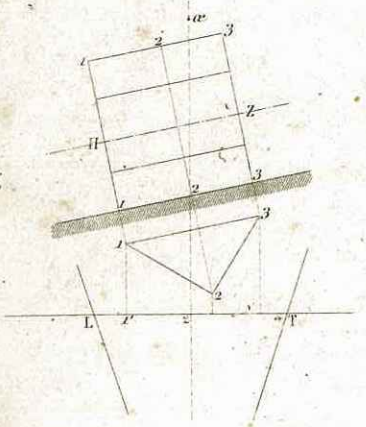


Fig. 87.

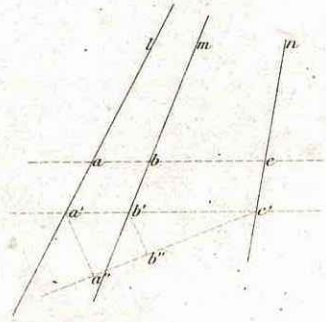


Fig. 85.

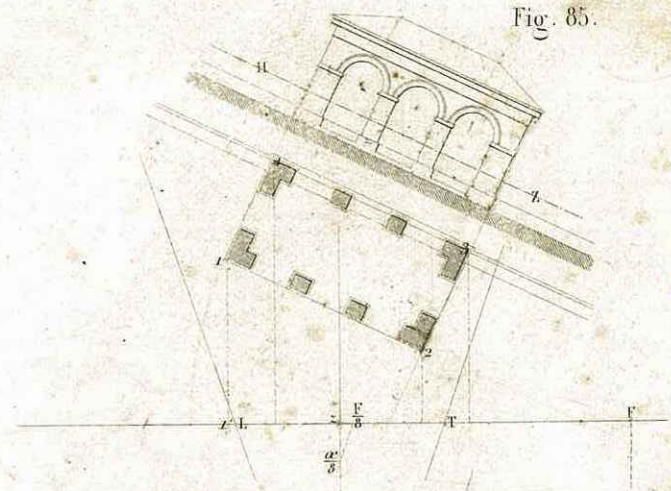


Fig. 84.

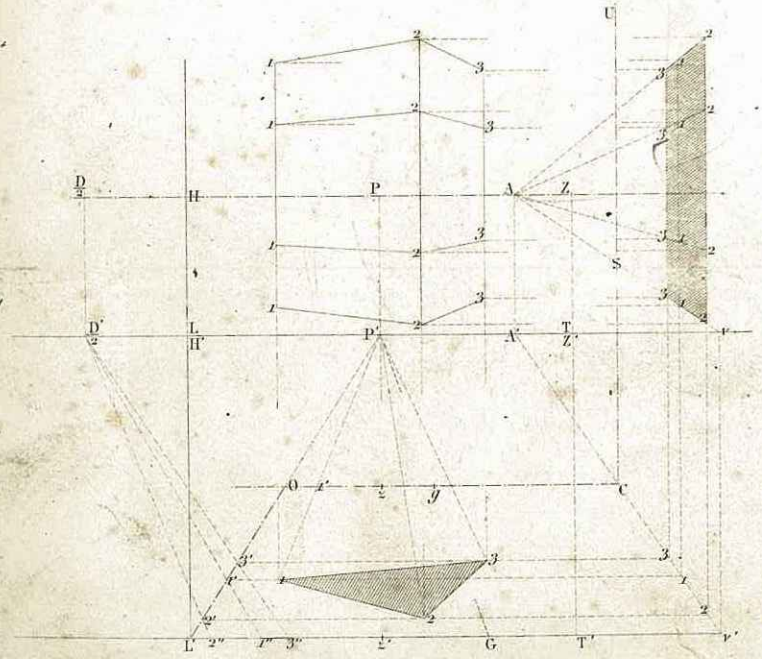
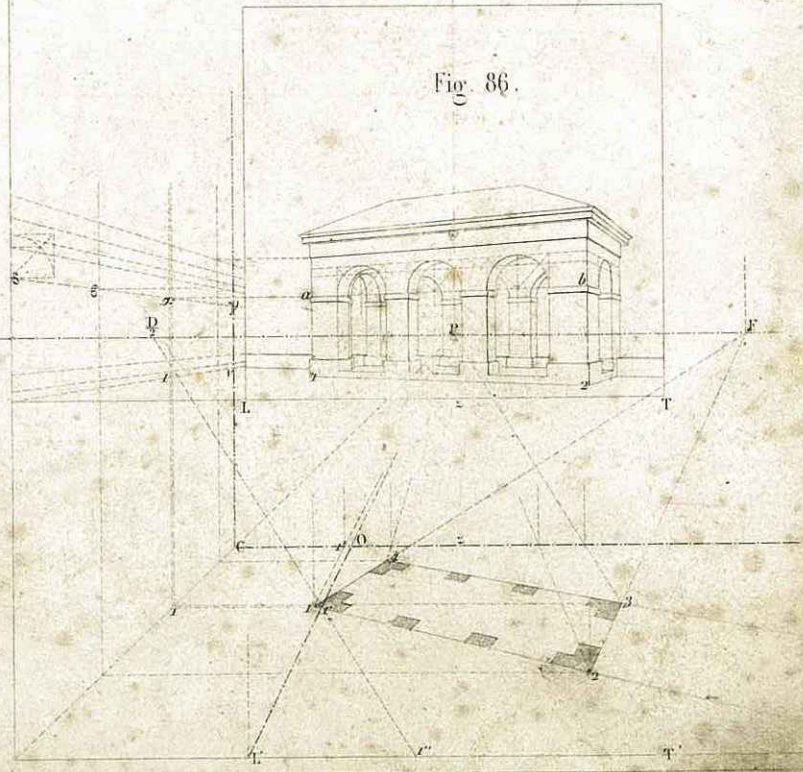
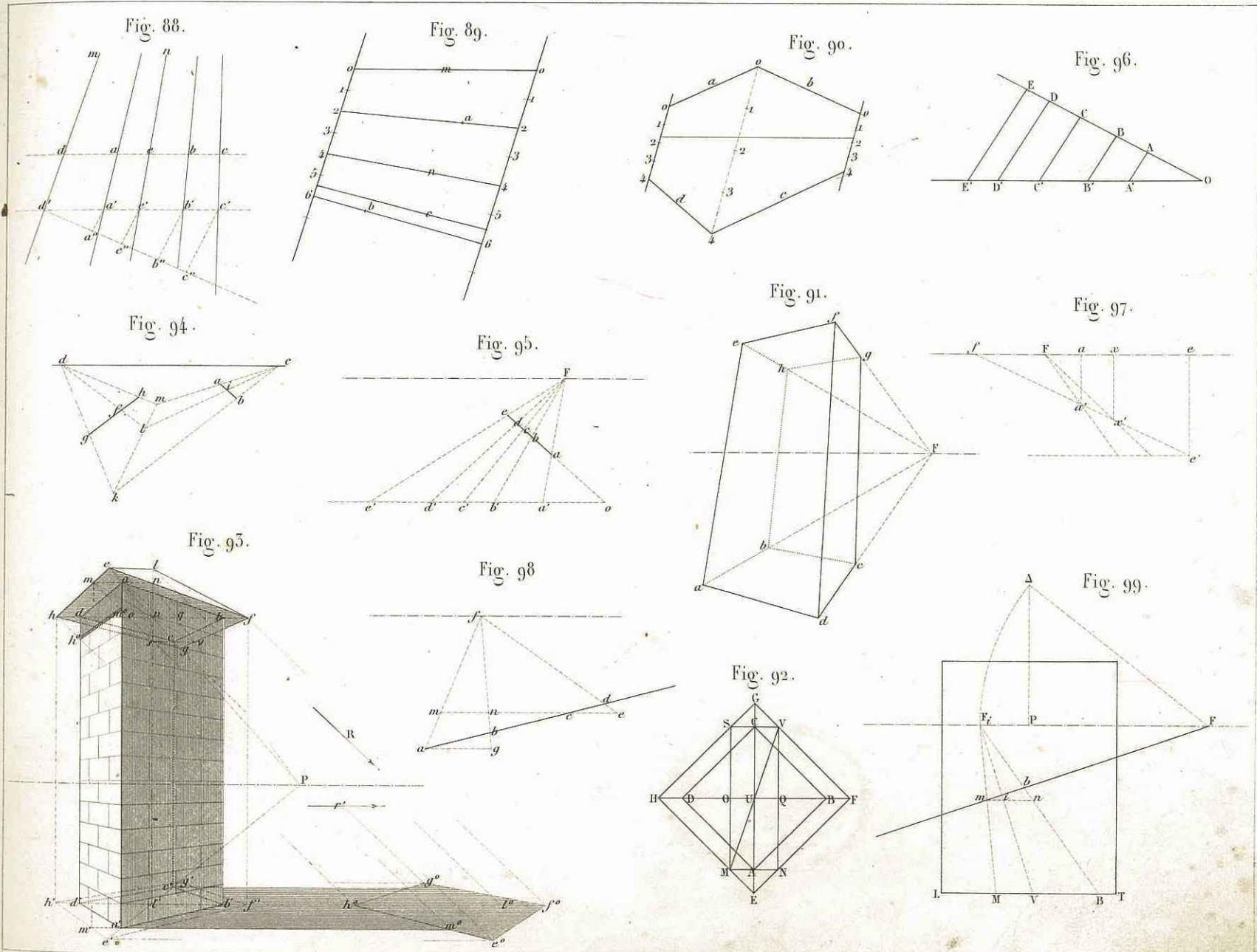


Fig. 86.







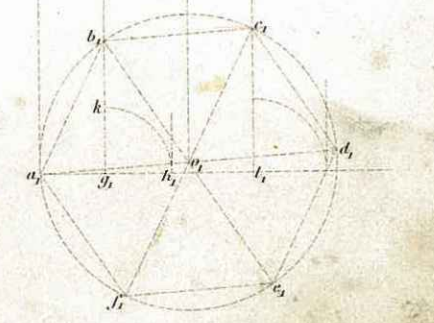
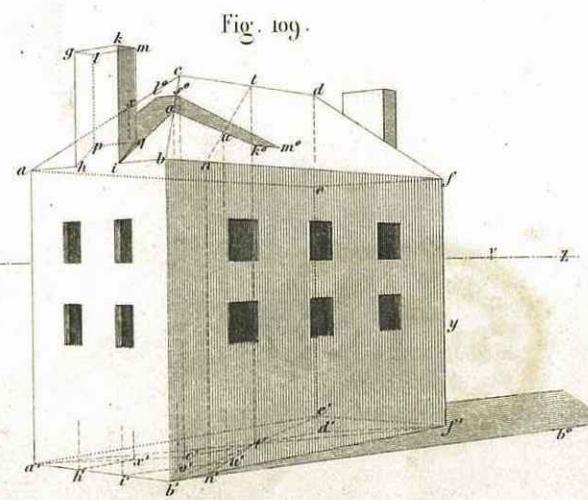
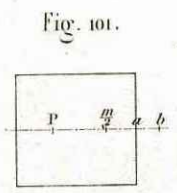
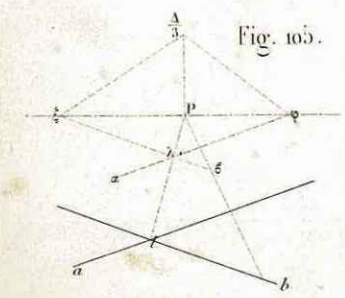
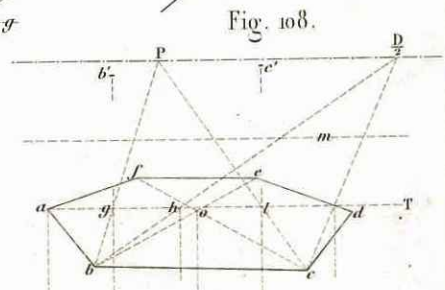
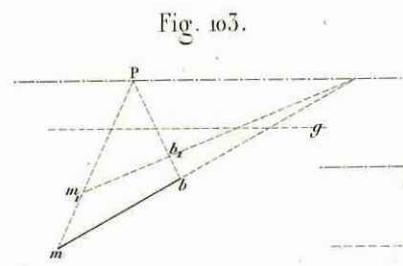
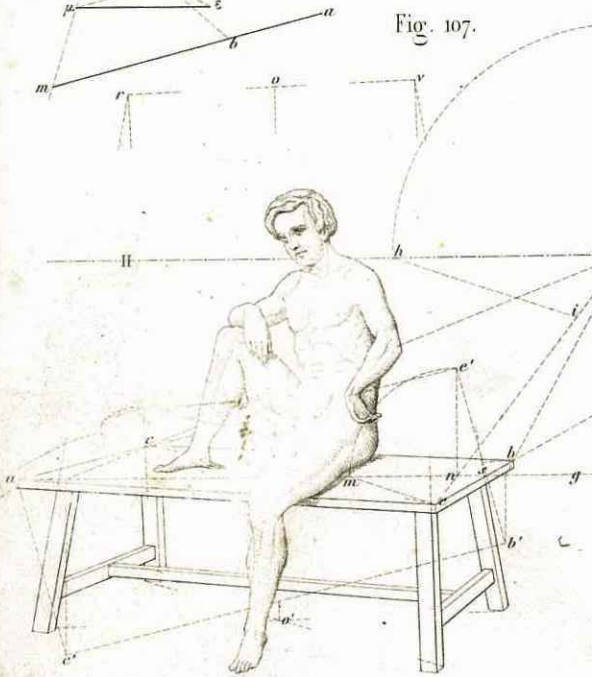
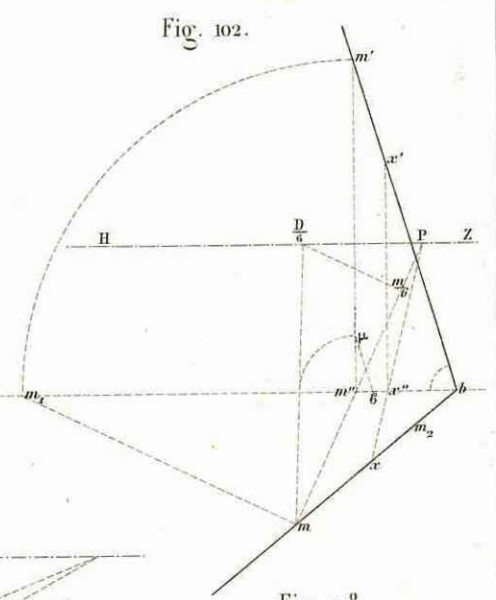
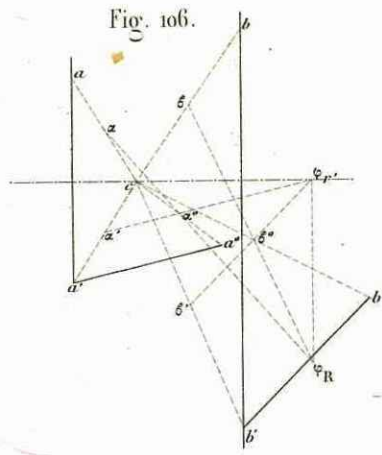
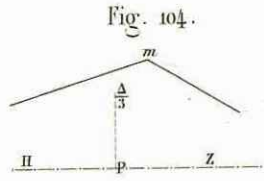
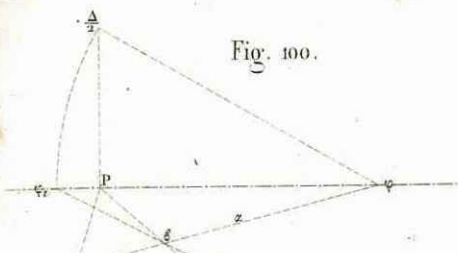


Fig. 110.

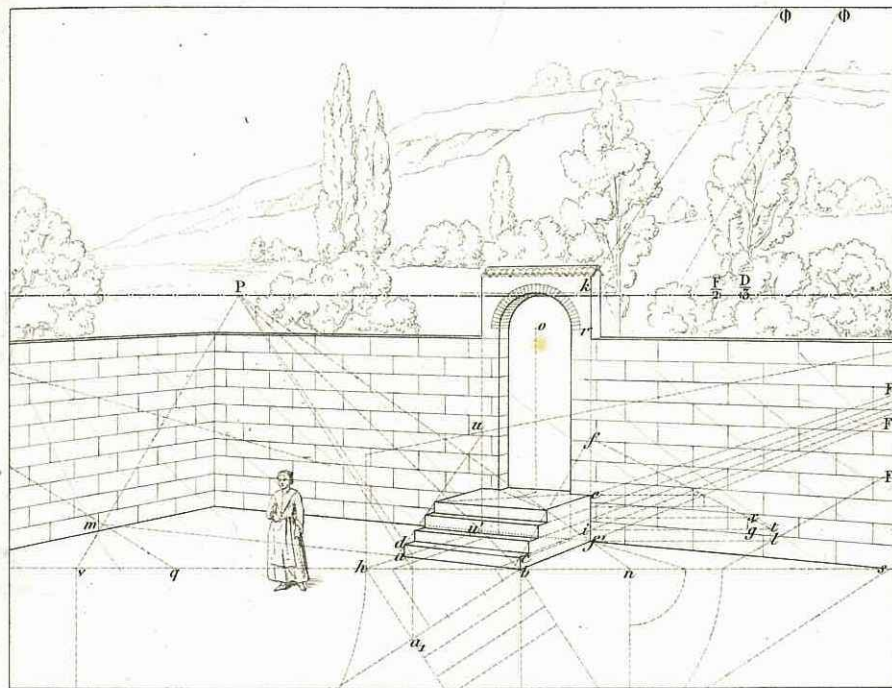


Fig. 112.

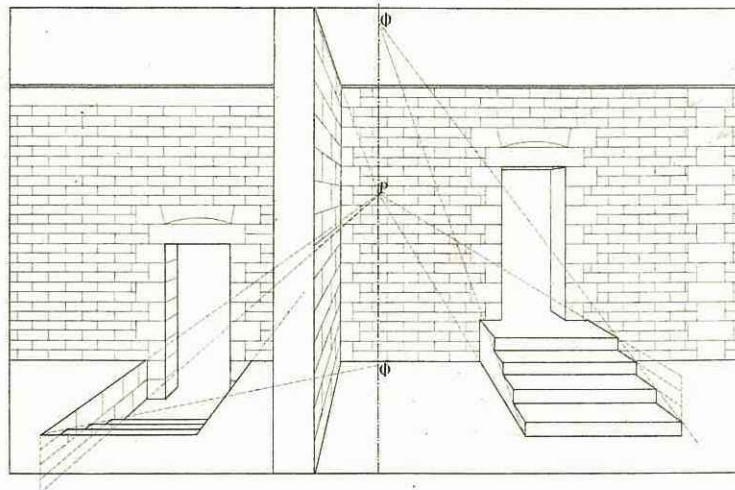


Fig. 113.

Fig. 111.

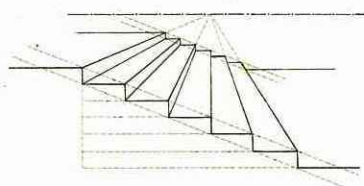


Fig. 114.

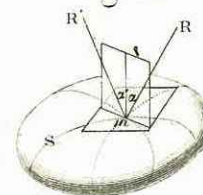


Fig. 116.

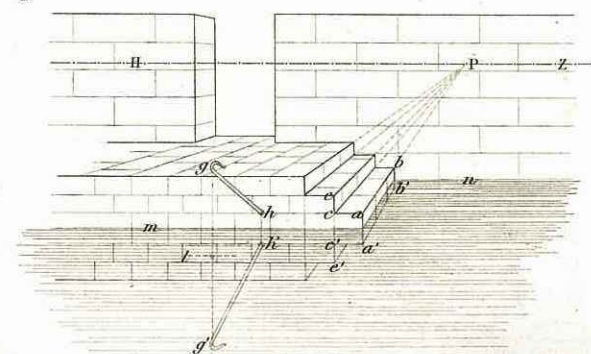


Fig. 115.

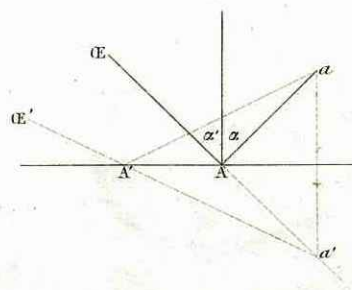


Fig. 117.

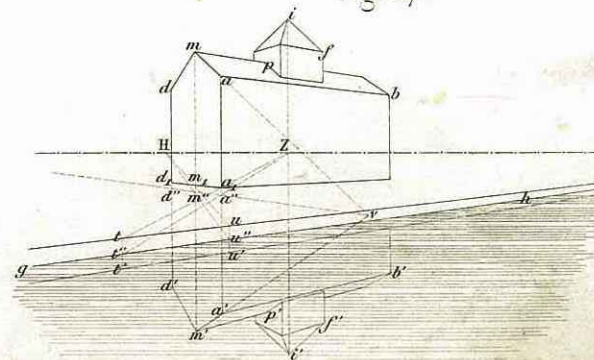


Fig. 118.

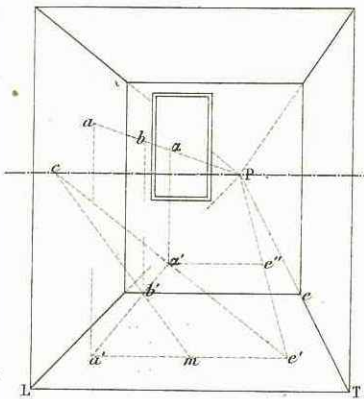


Fig. 119.

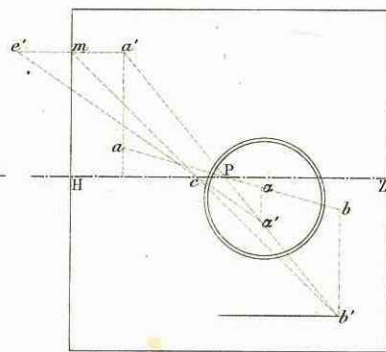


Fig. 120.

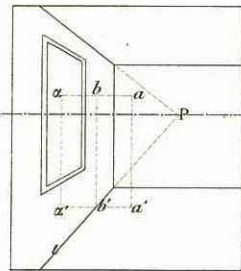


Fig. 121.

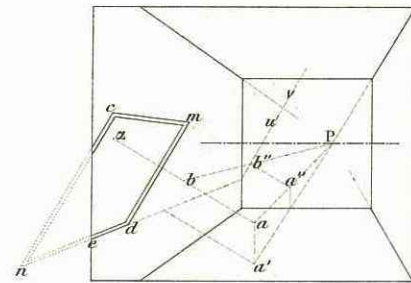


Fig. 122.

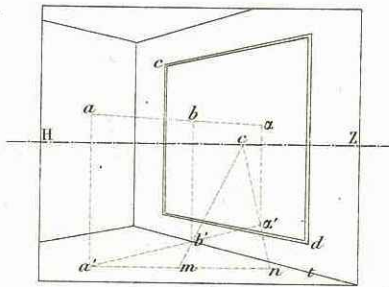


Fig. 127.

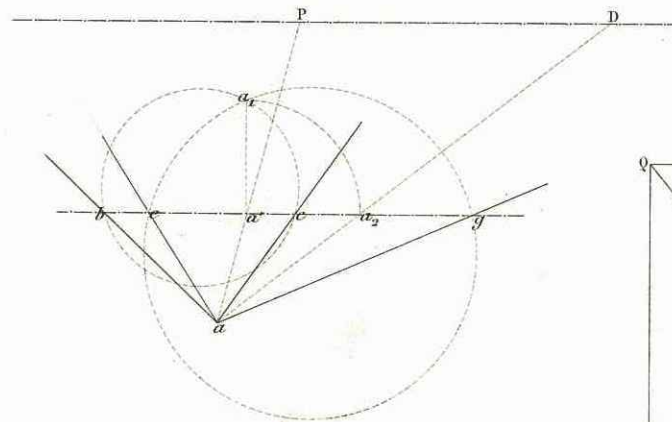


Fig. 123.

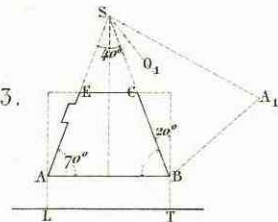


Fig. 124.

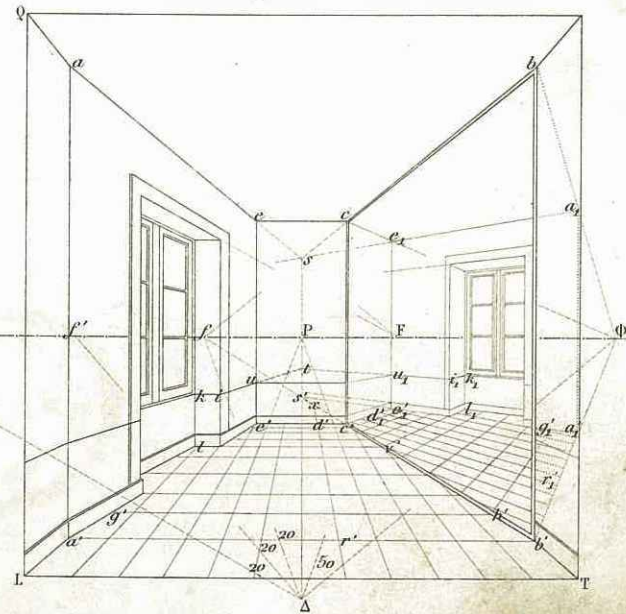


Fig. 125.

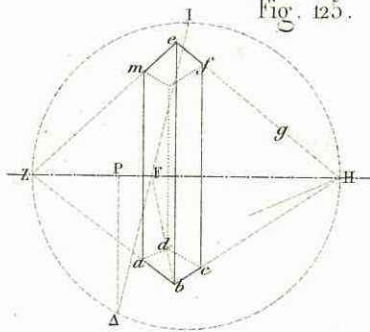
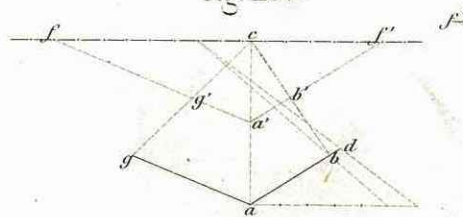
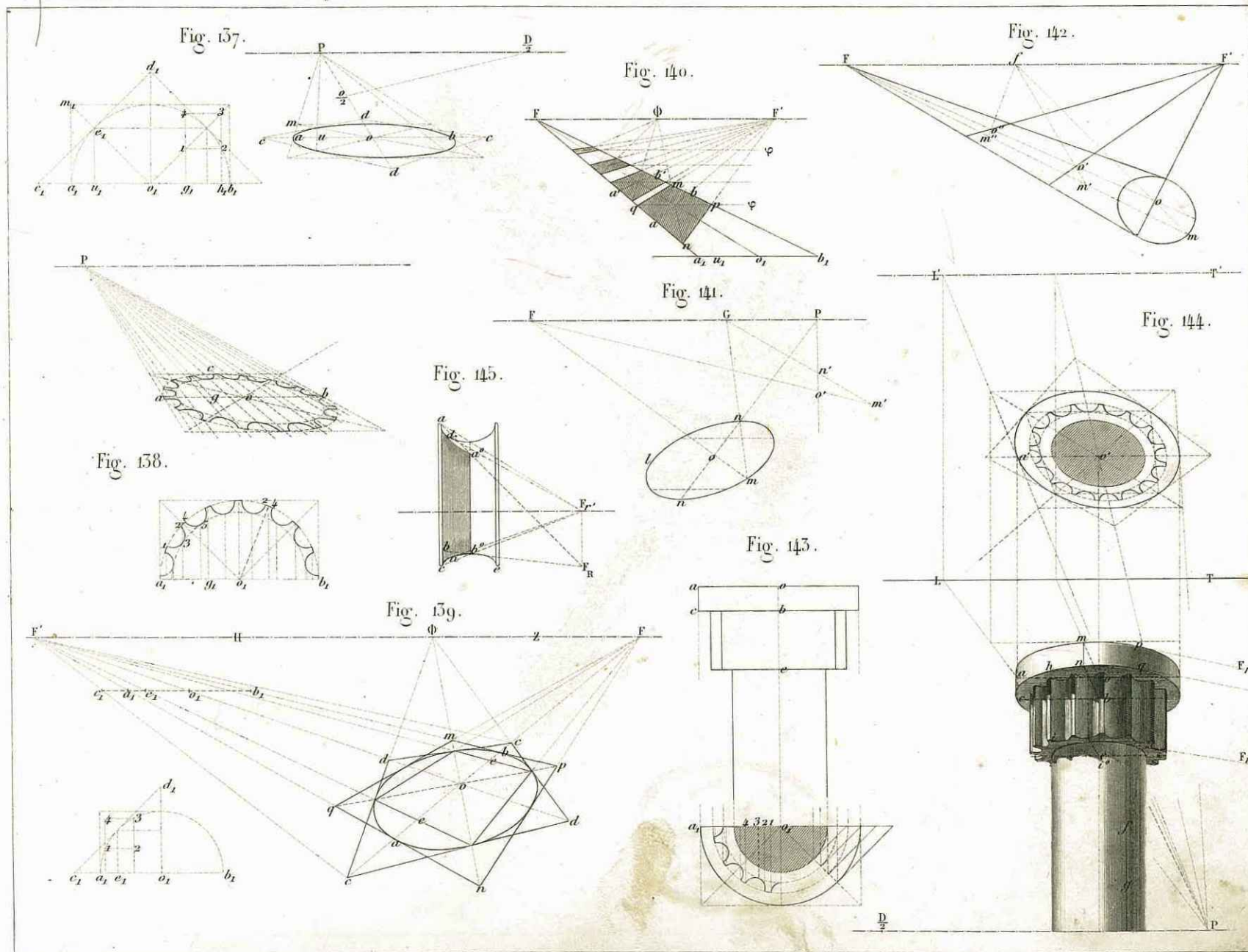


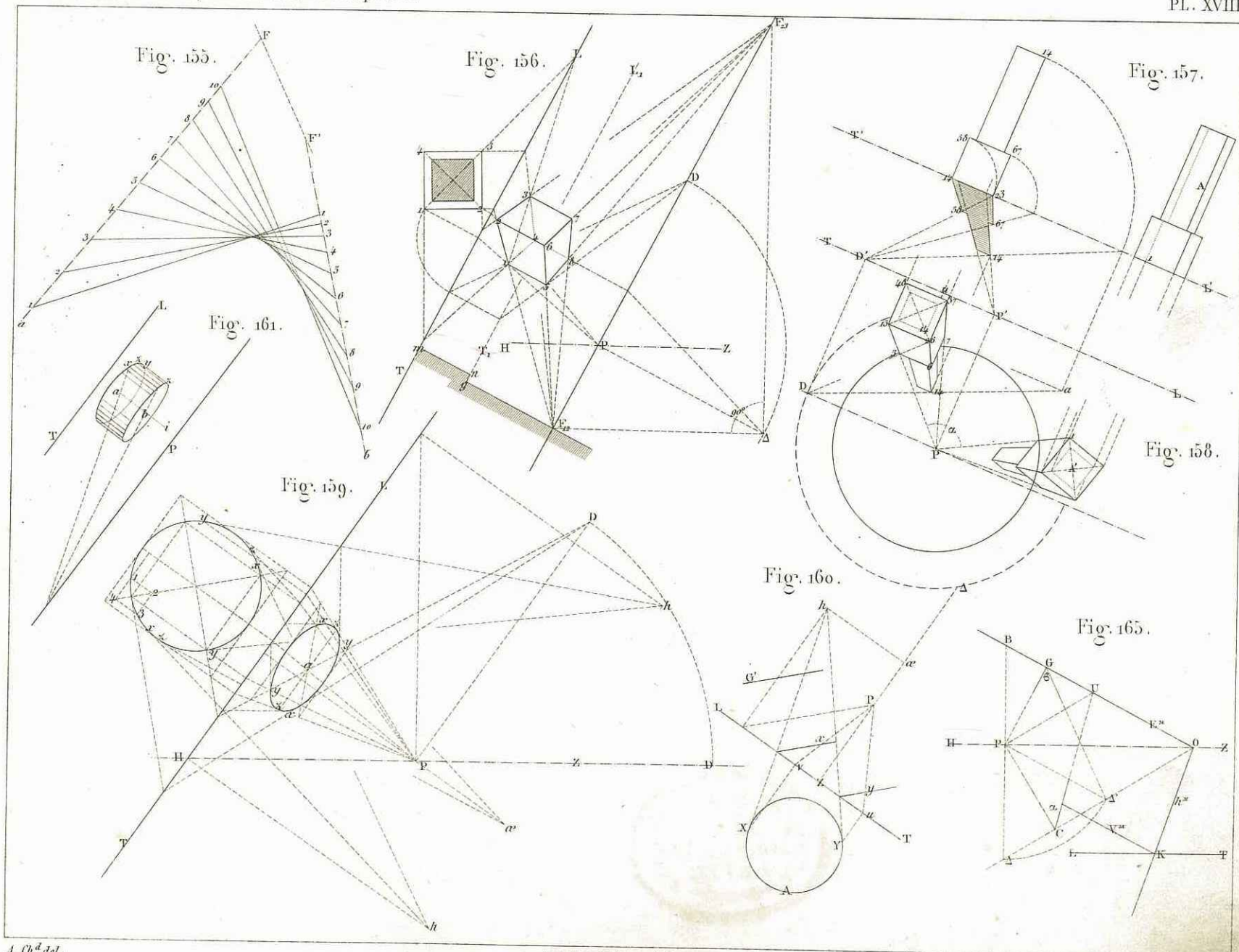
Fig. 126.

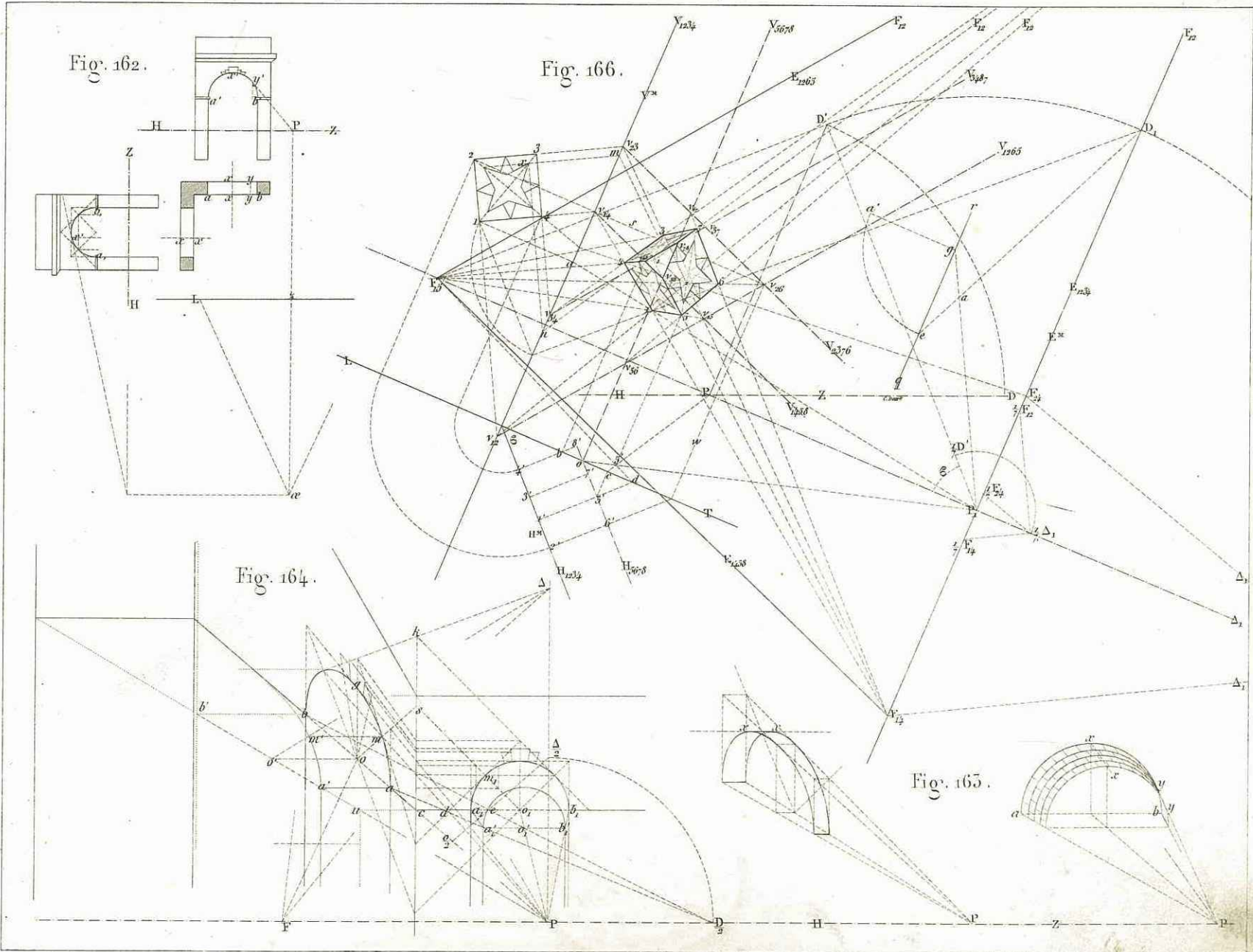




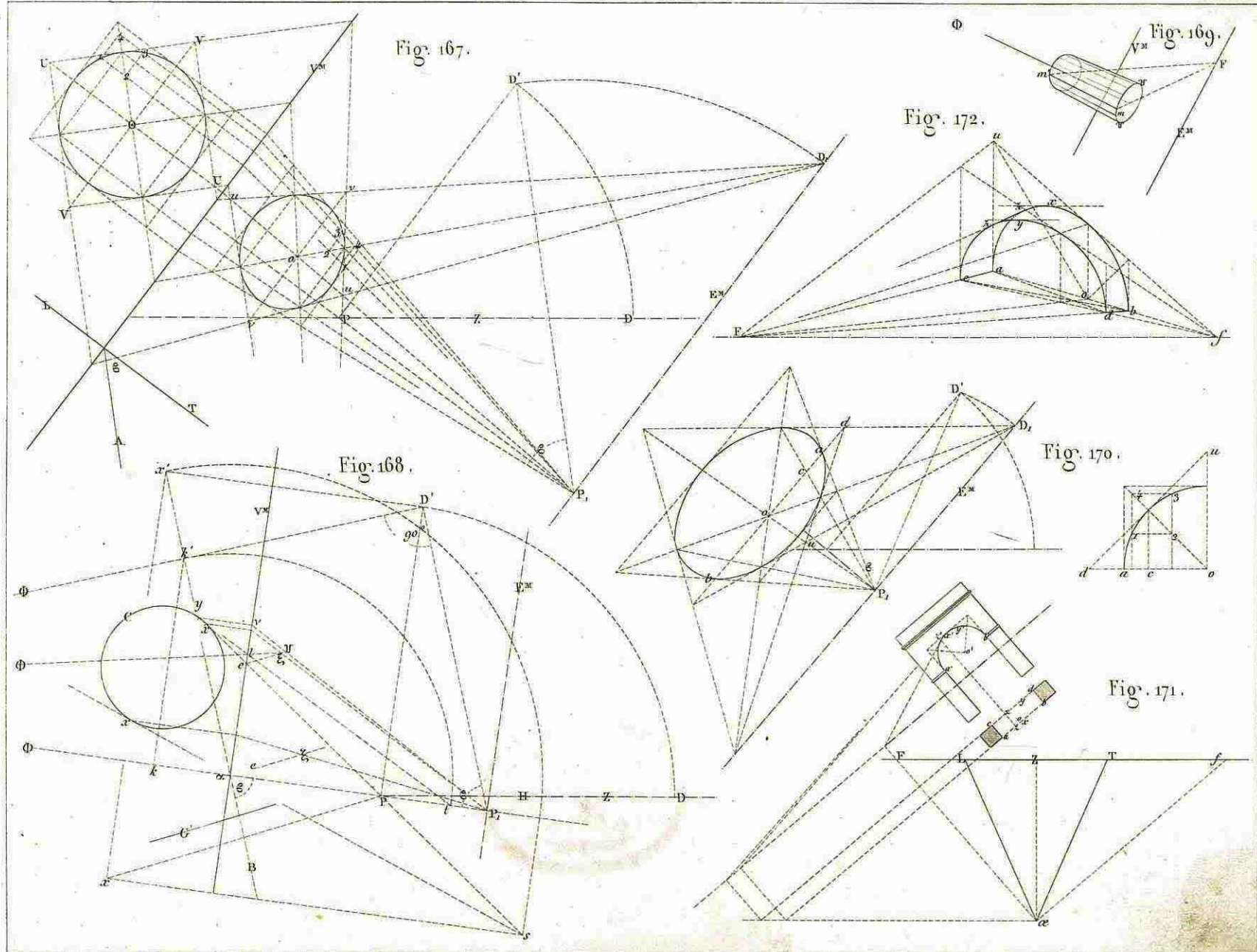












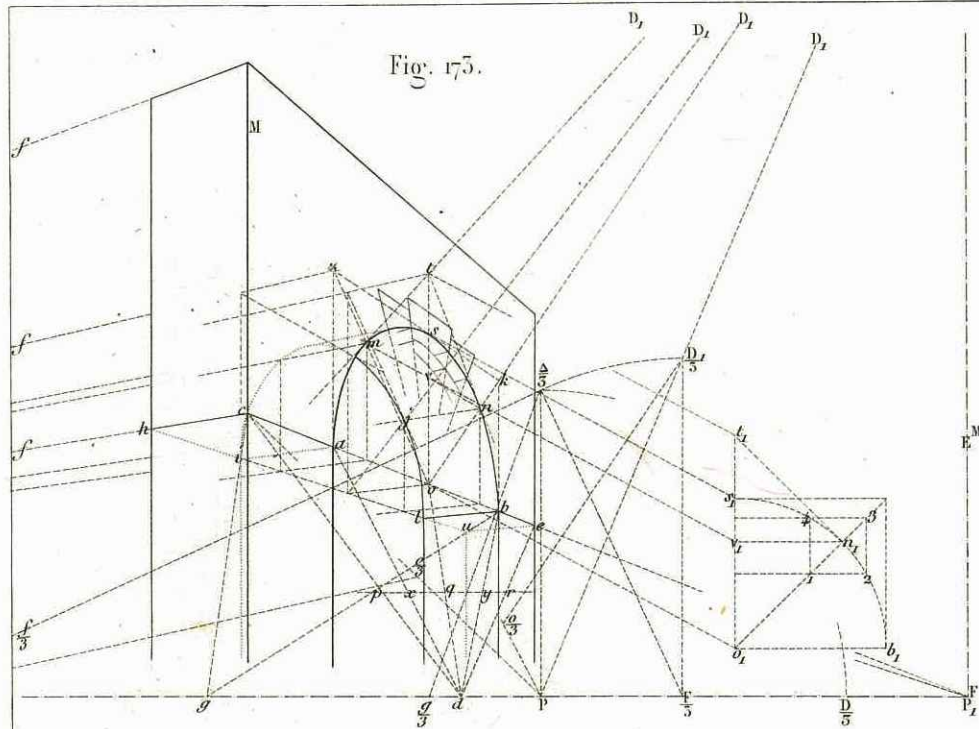


Fig. 175.

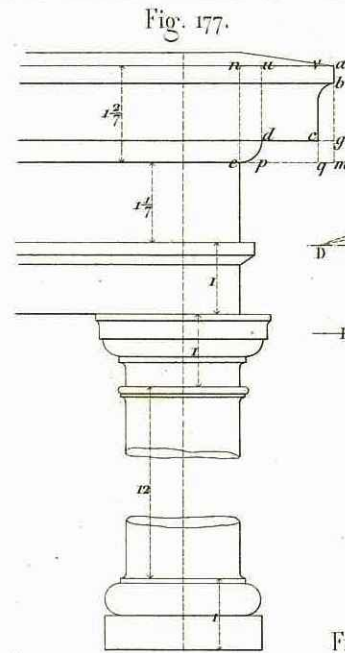


Fig. 177.

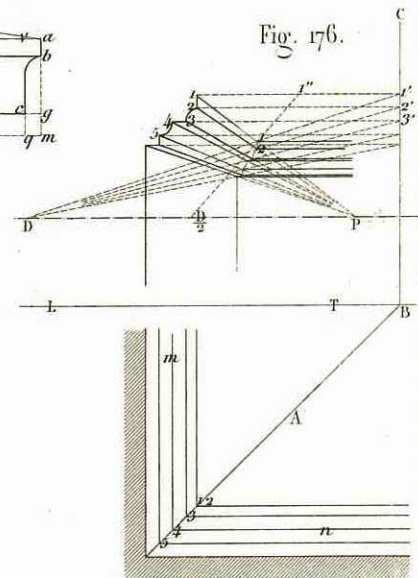


Fig. 176.

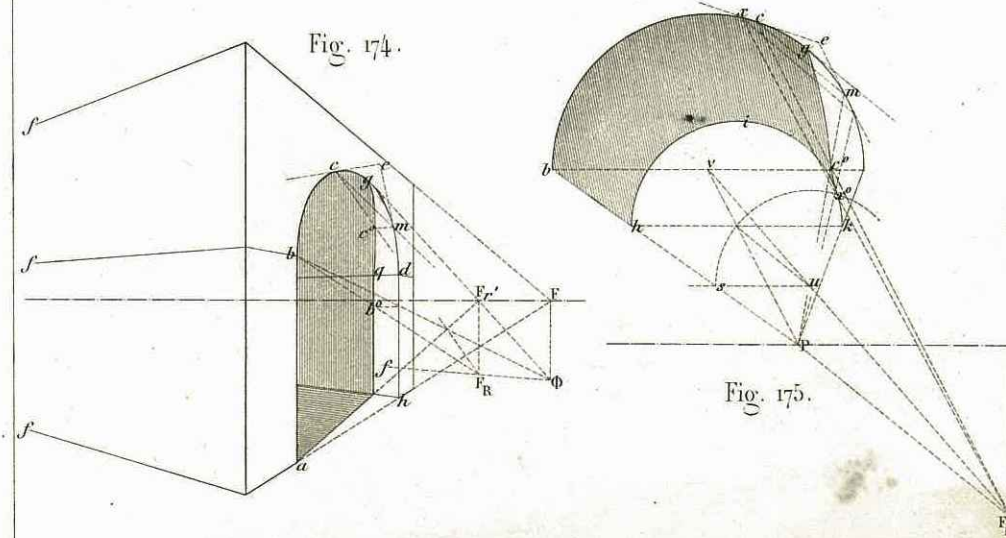


Fig. 174.

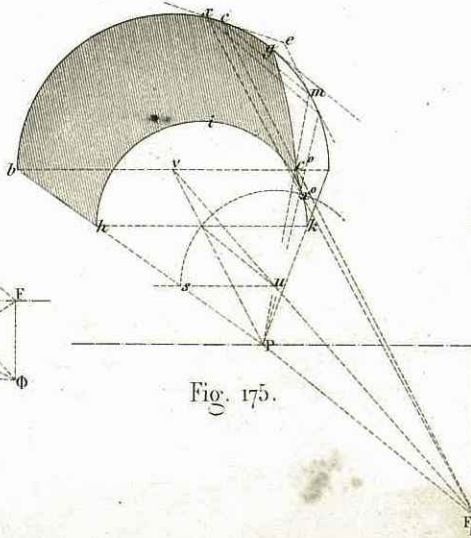


Fig. 175.

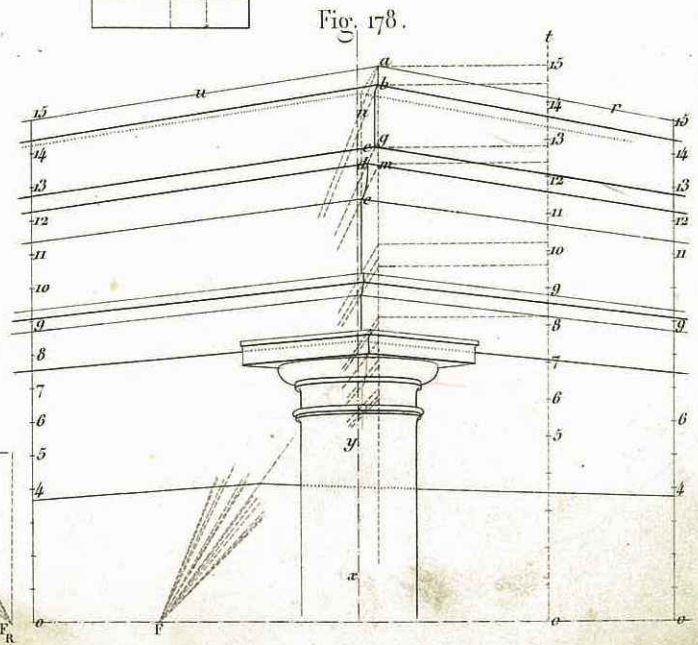
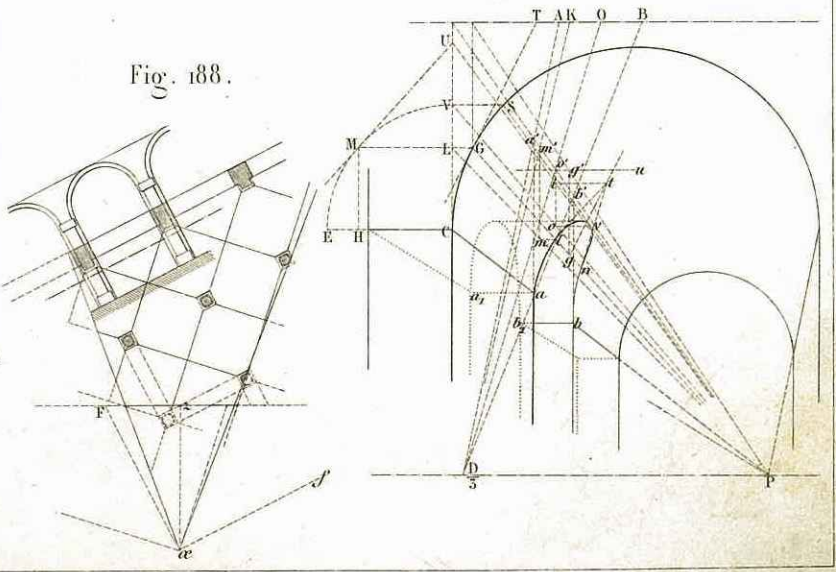
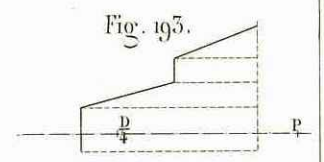
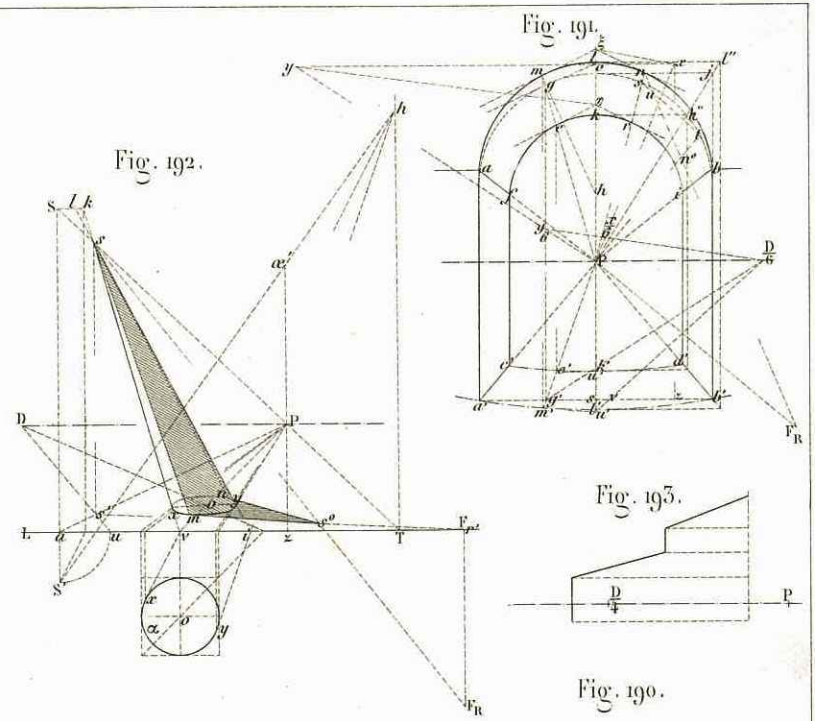
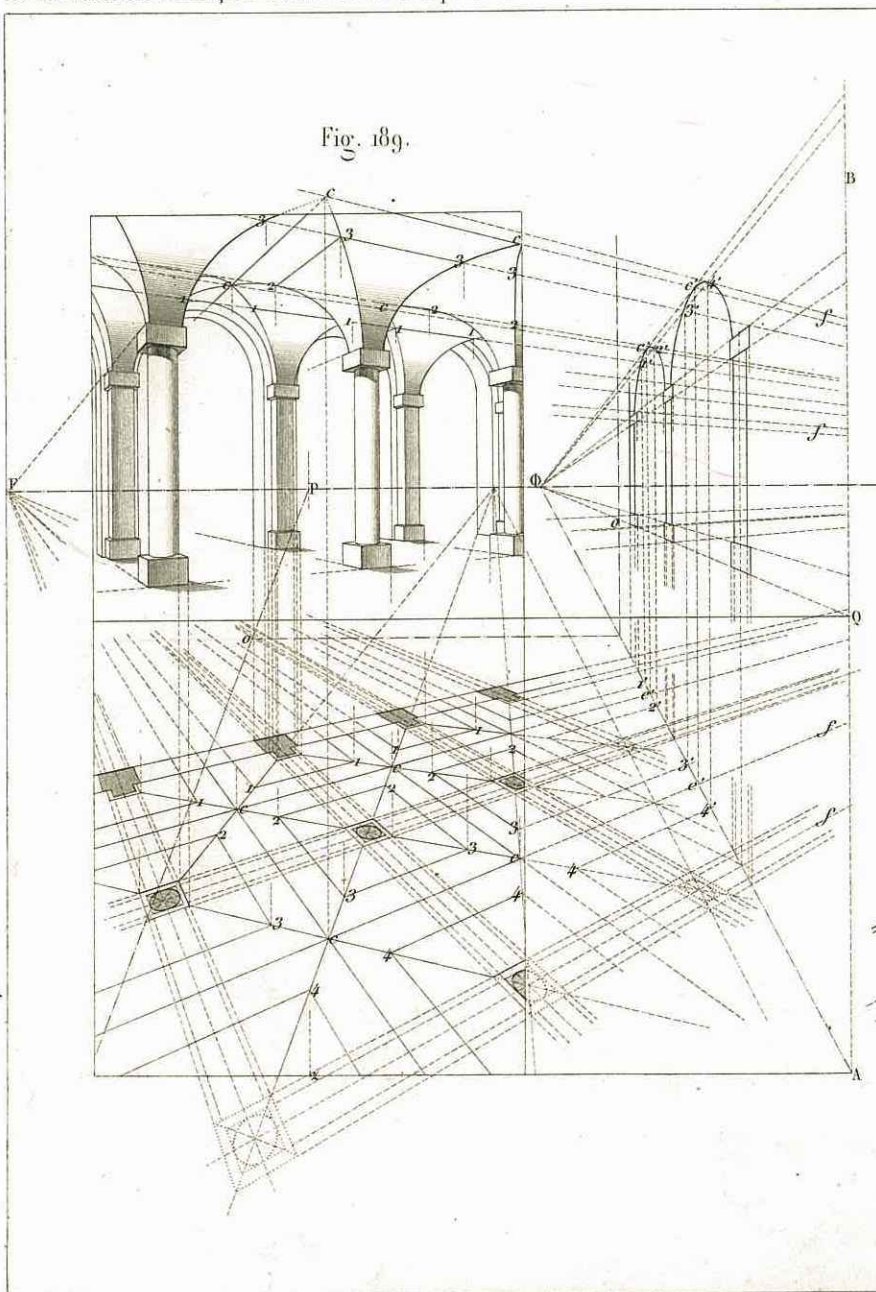


Fig. 178.







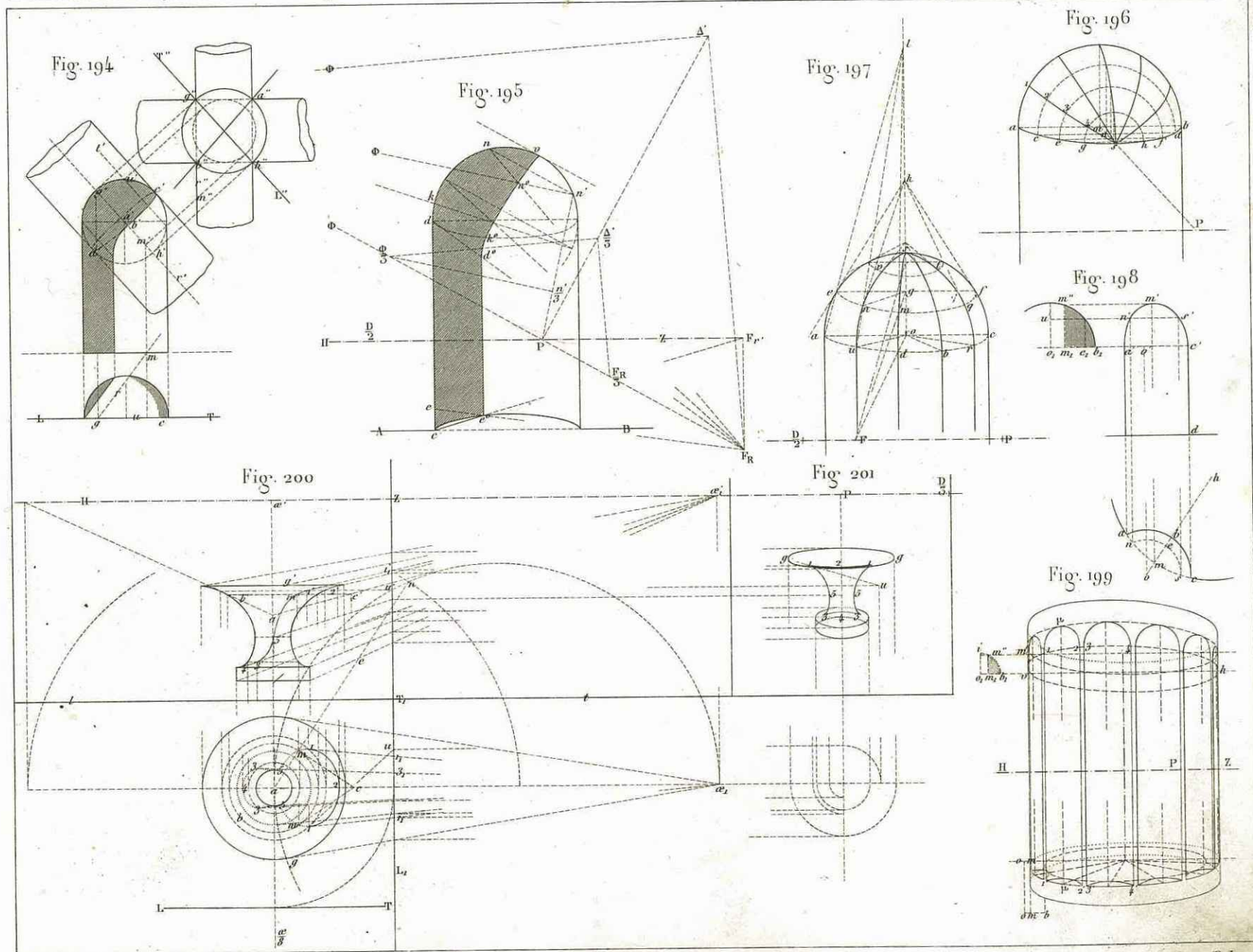


Fig 202

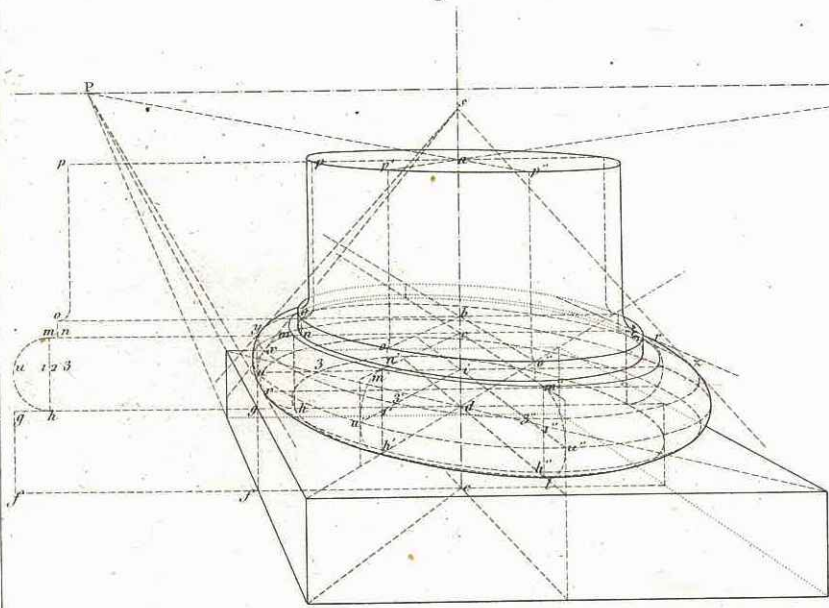


Fig. 207

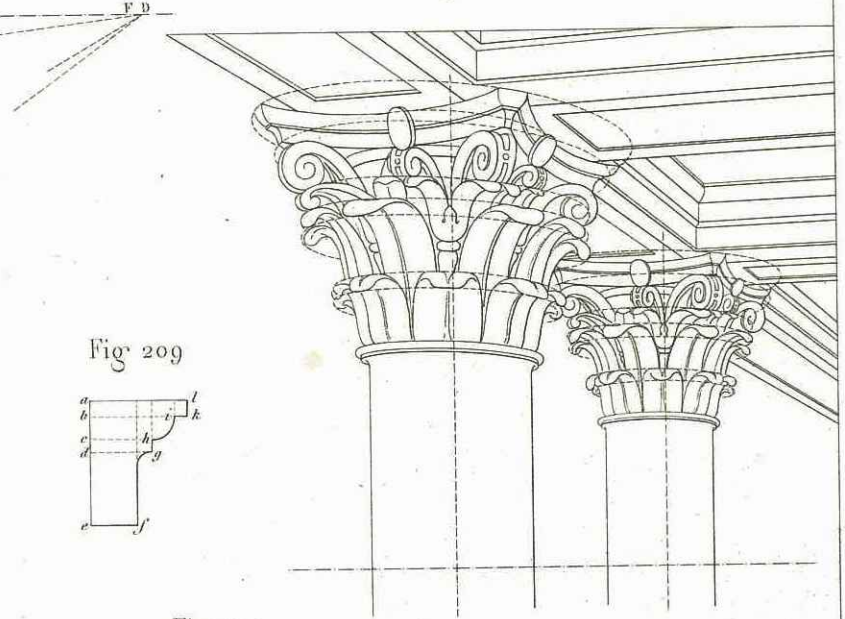


Fig 209

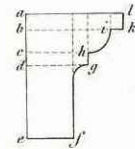


Fig. 203

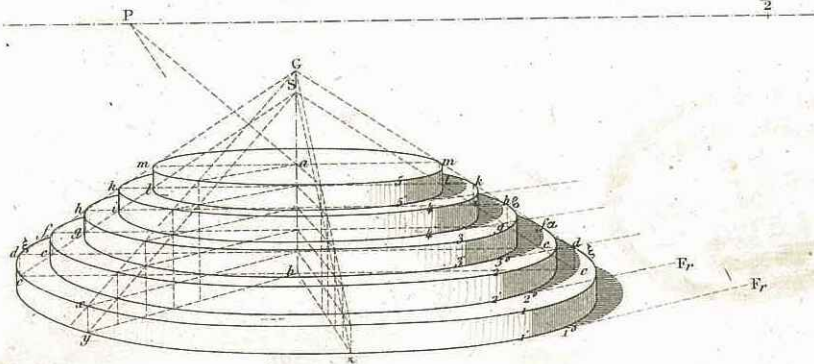


Fig: 210

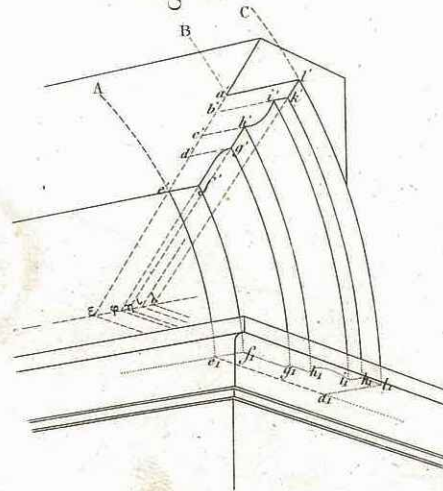
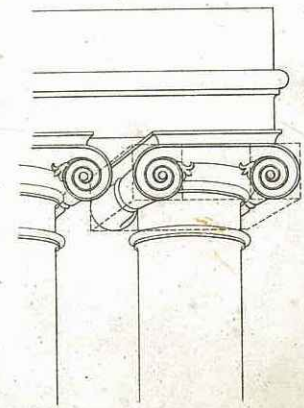
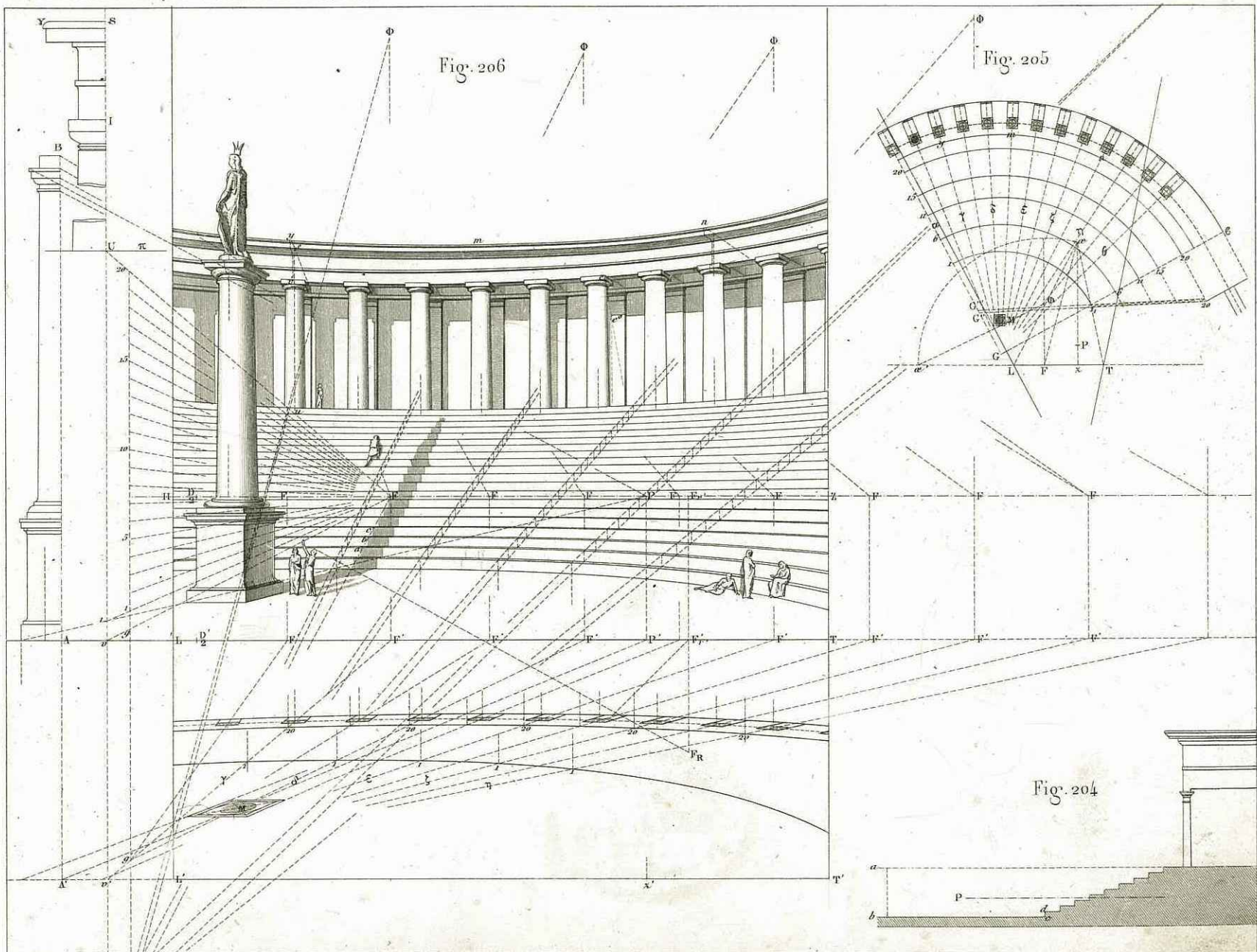


Fig: 208





Julien del

Gauthier Villars editeur

Dulos sc



Fig. 212

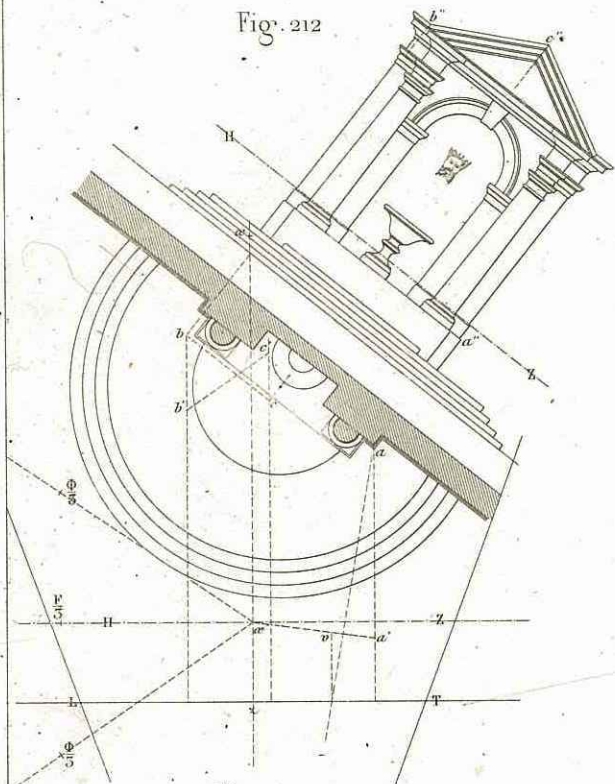


Fig. 211

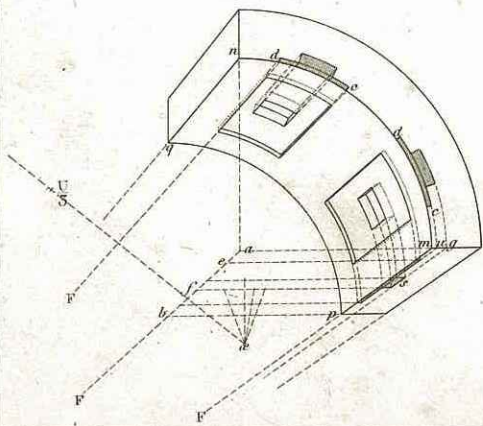
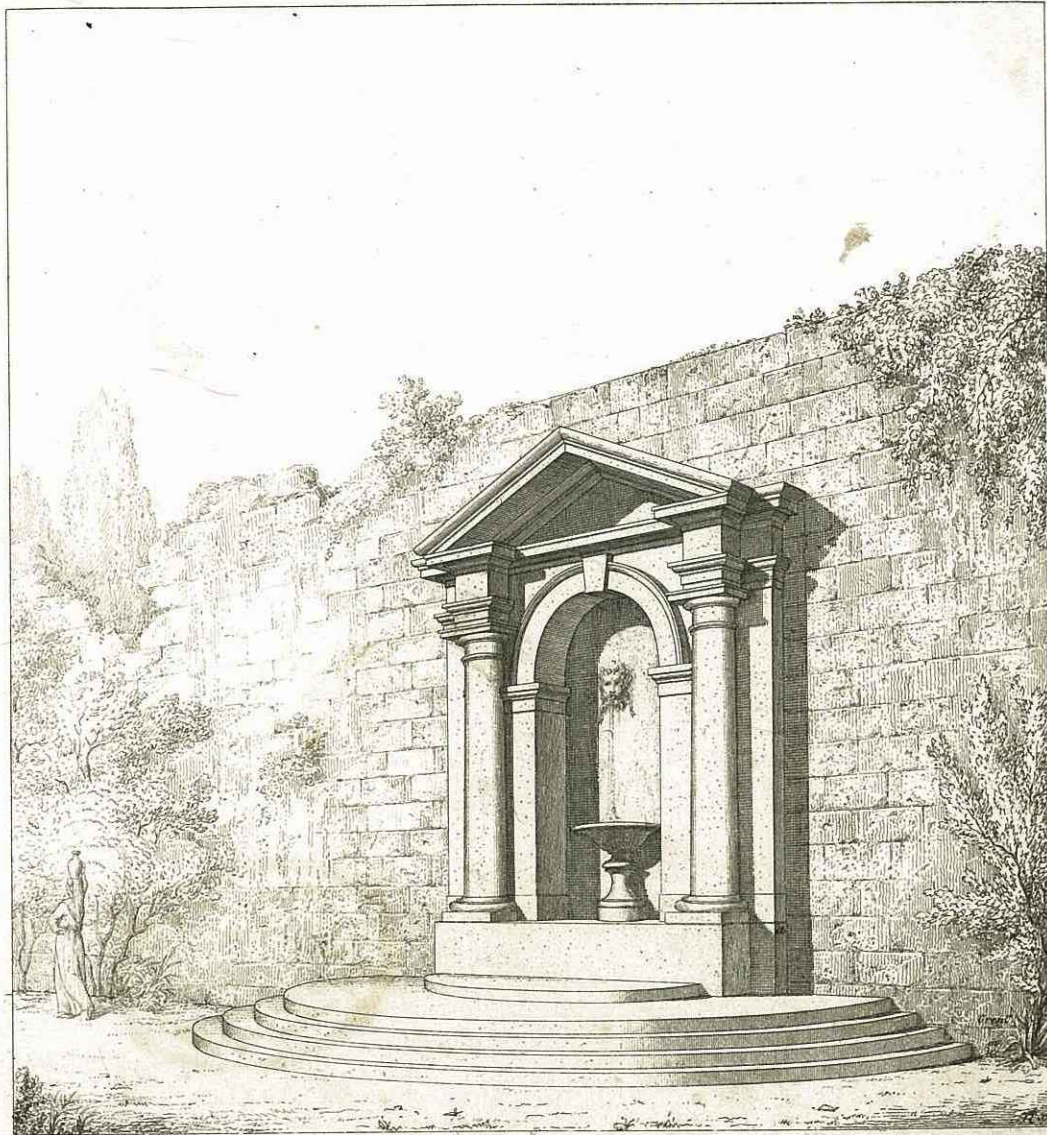


Fig. 213



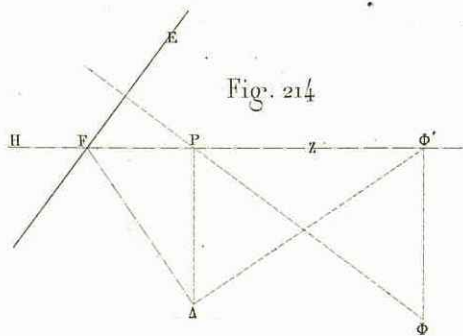


Fig. 214

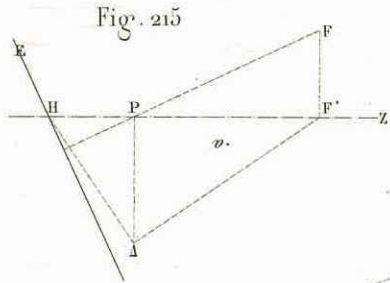


Fig. 215

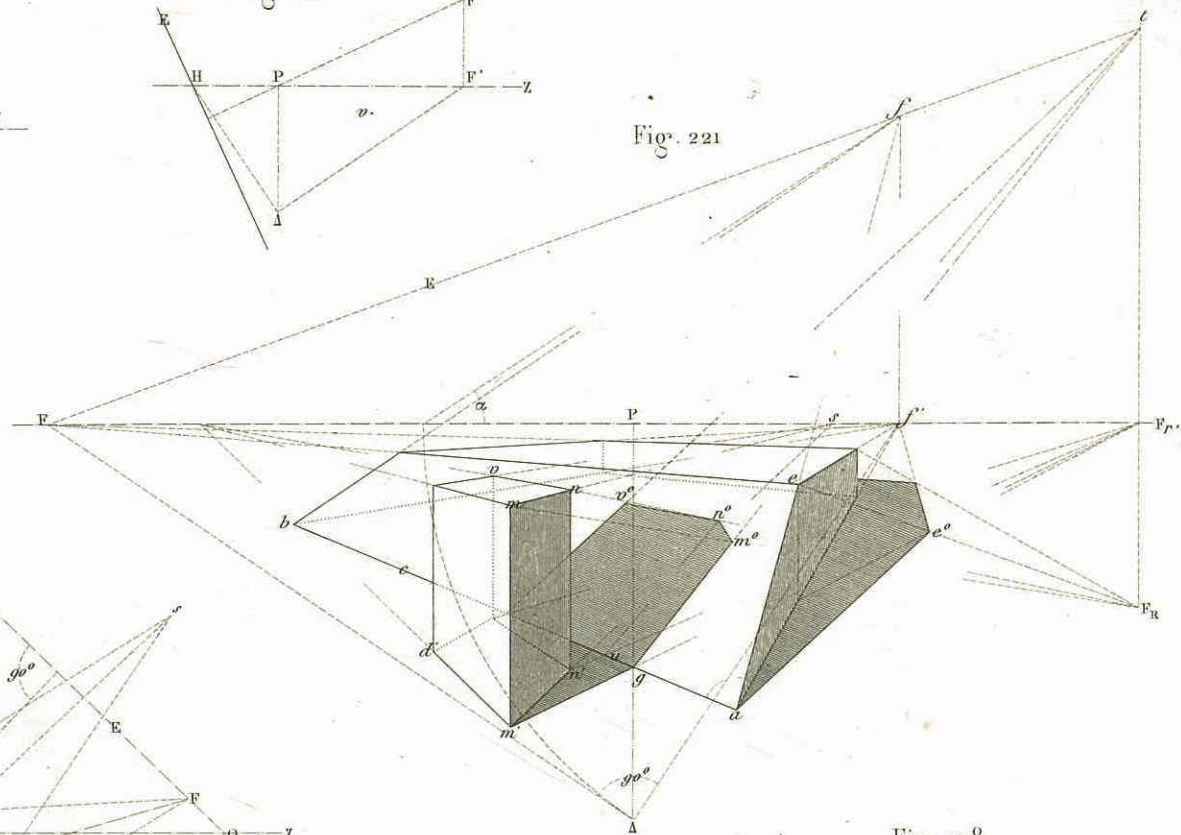


Fig. 221

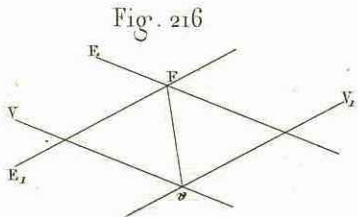


Fig. 216

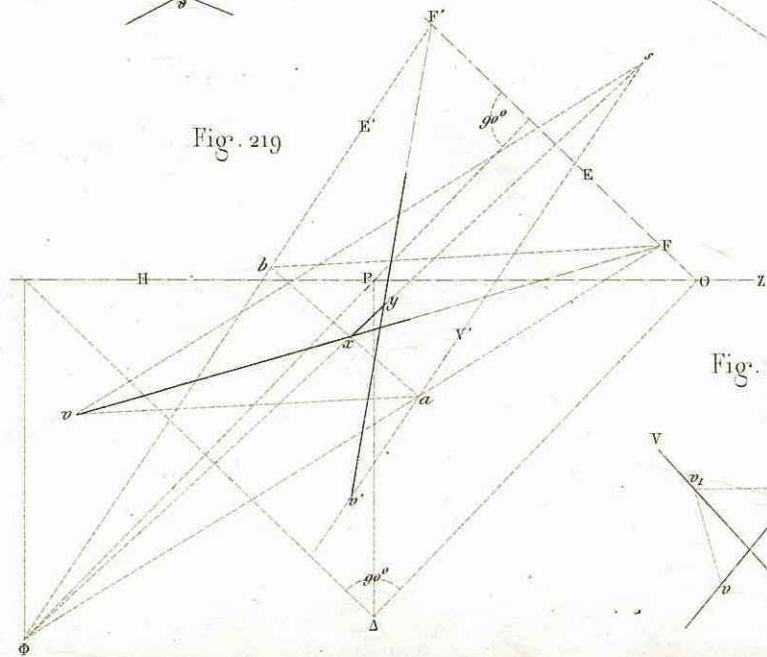


Fig. 219

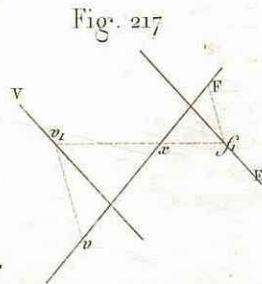


Fig. 217

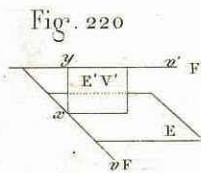


Fig. 220

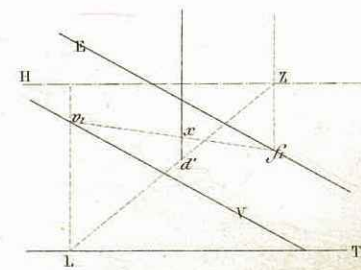
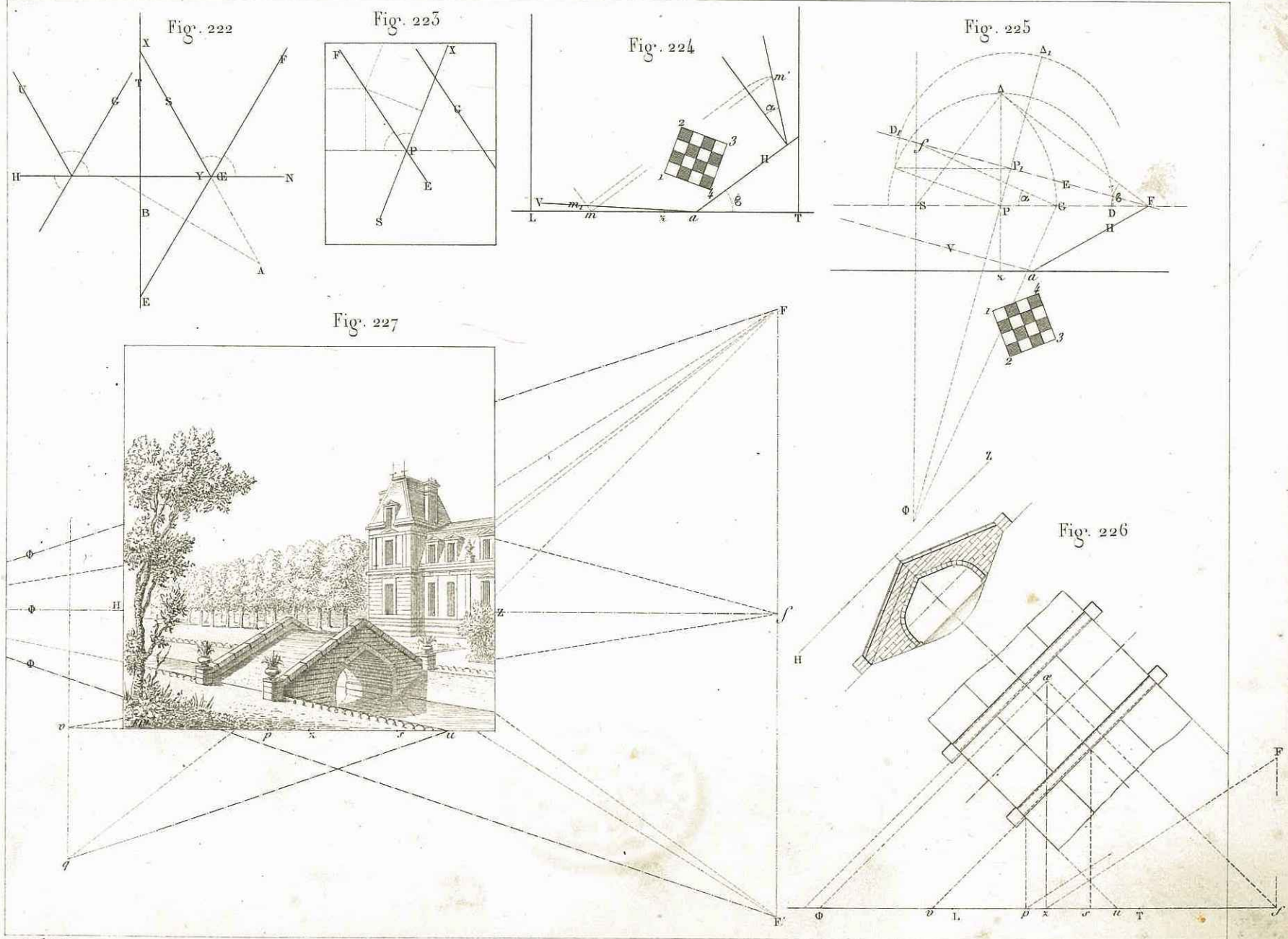


Fig. 218



A. Ch. del

Cautier-Villars éditeur

Dulos sc.

